

# ARC155

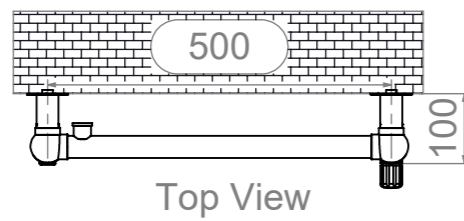

## Installation Accessories:

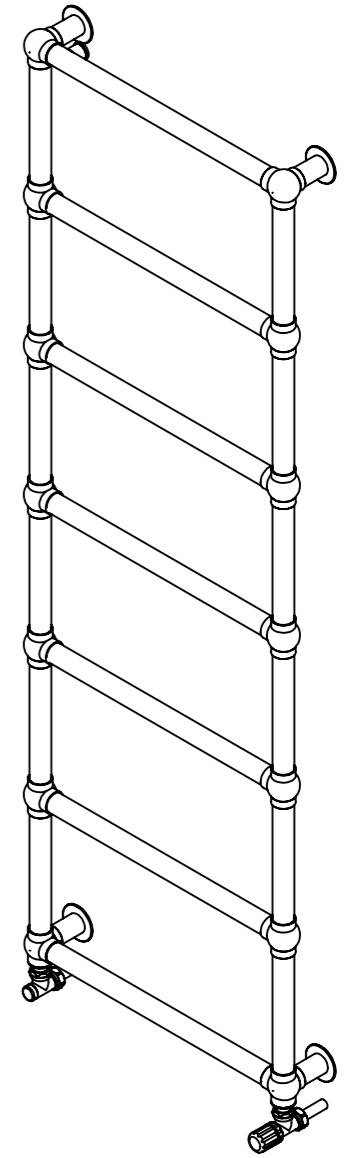
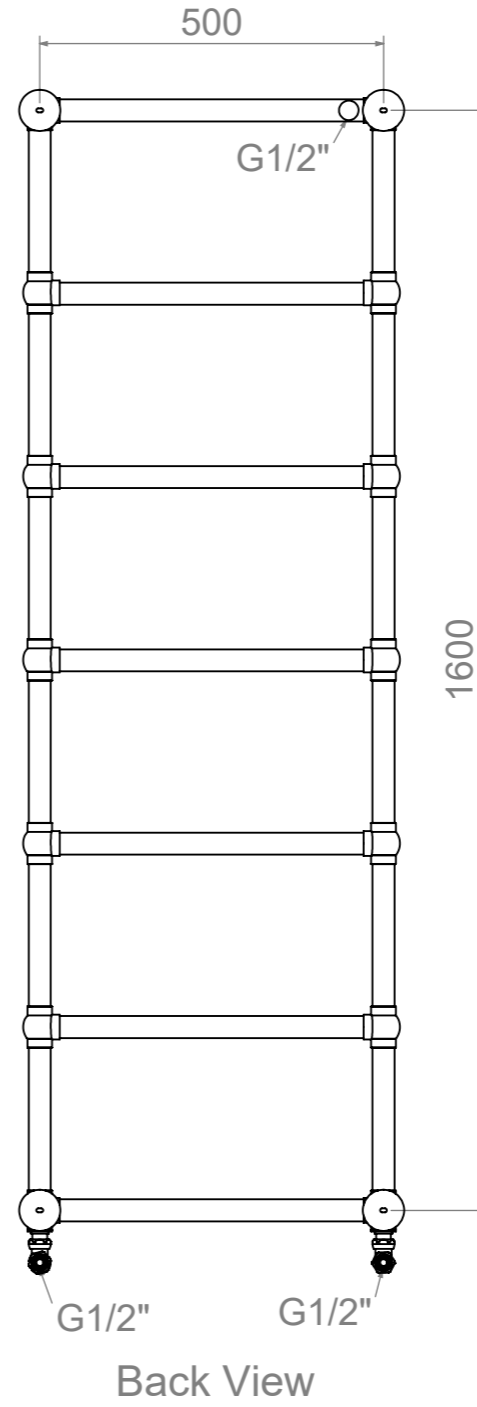
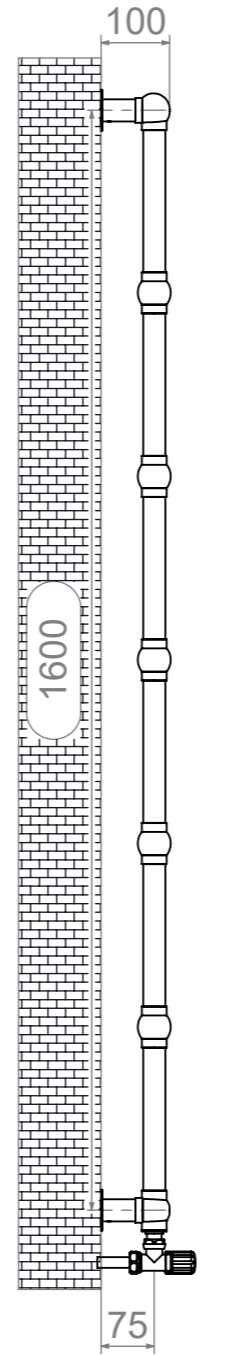
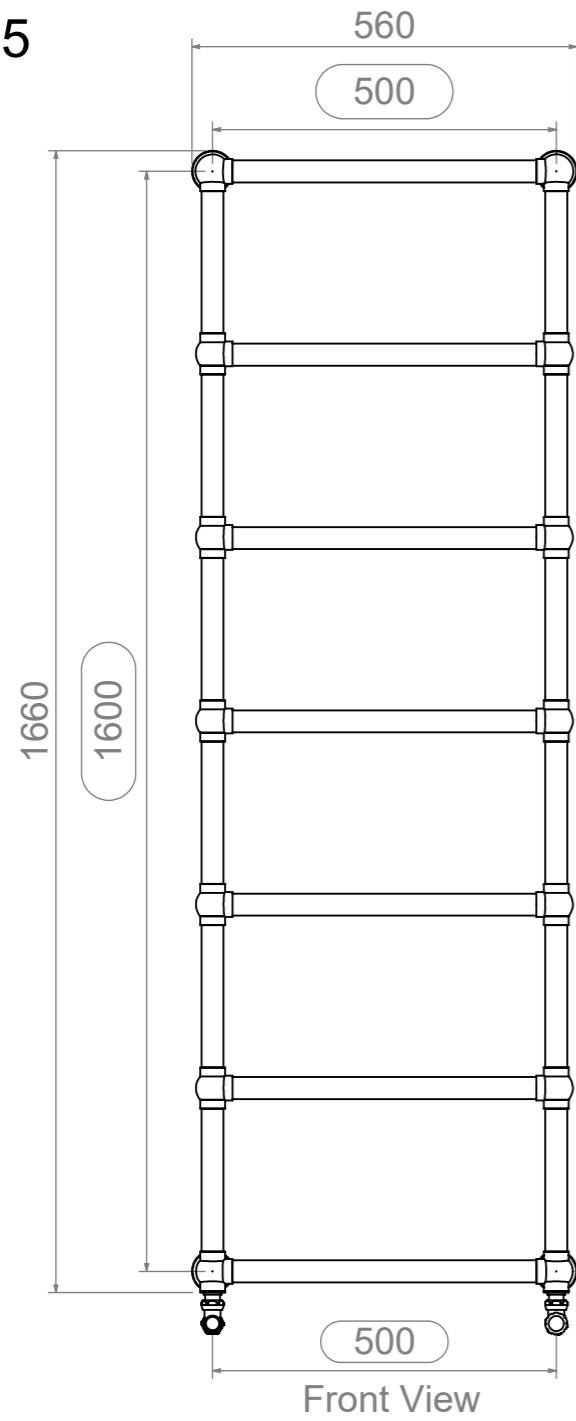
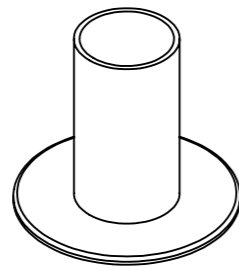

## Fitting Position:

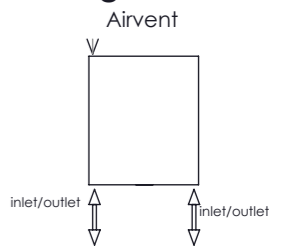

All Dimension are in mm  
 Max.Working Pressure = 10 Bar  
 Max.Working Temperature=95° C  
 Inlet / Outlet : 1/2" BSP