

ARAT E14-5050

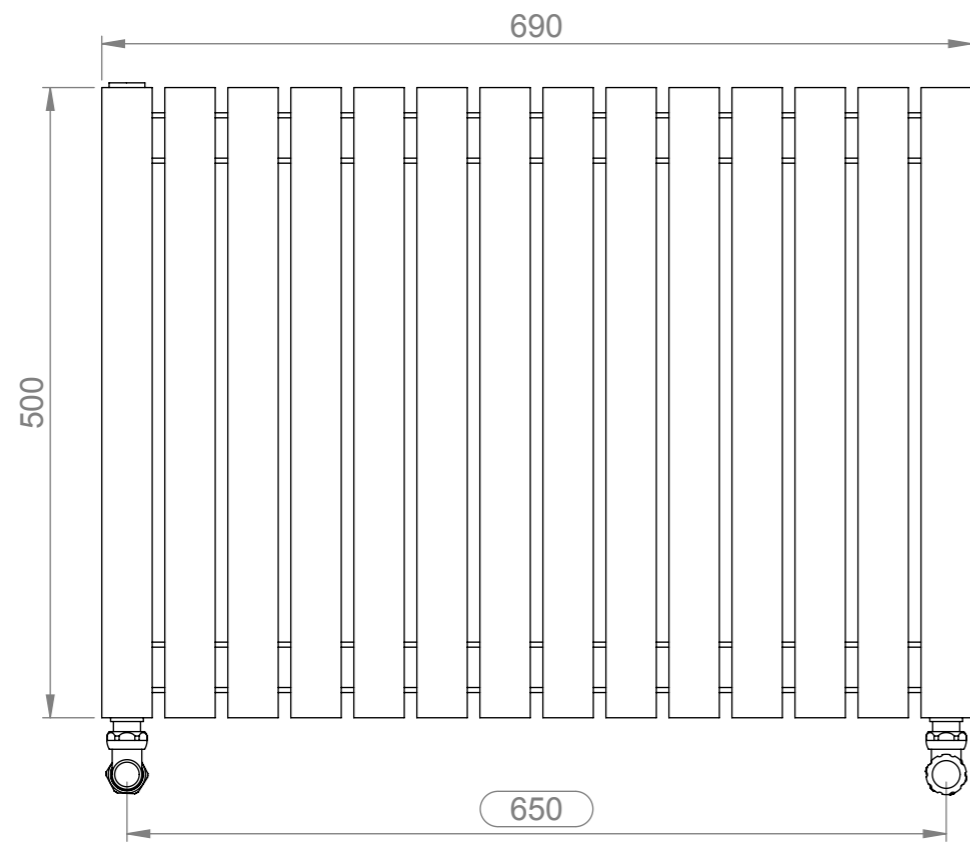

Front View

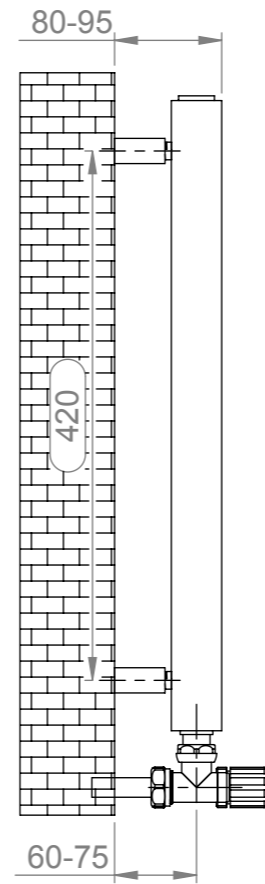

Side View

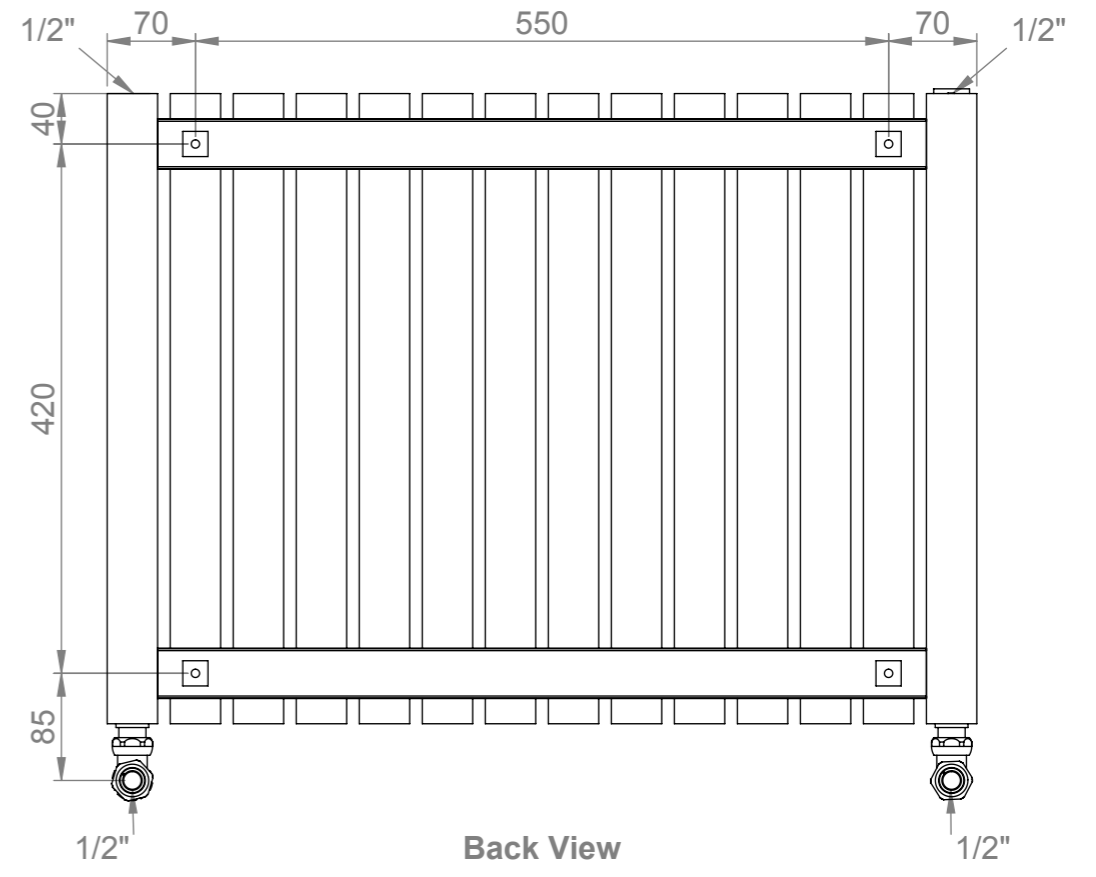

Back View

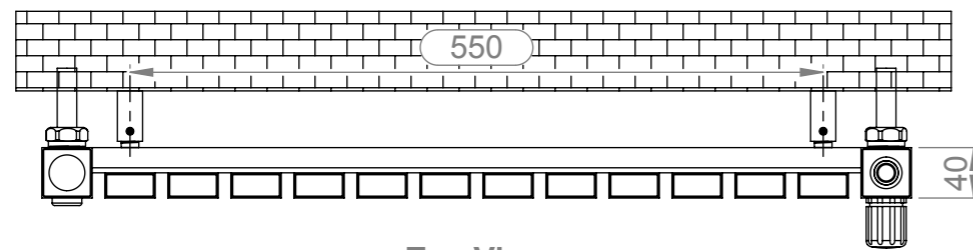

Top View

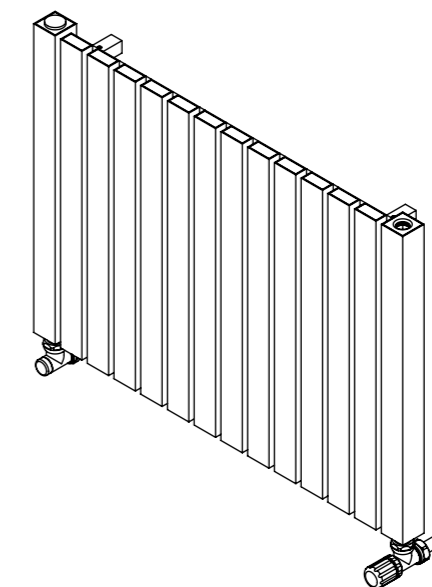



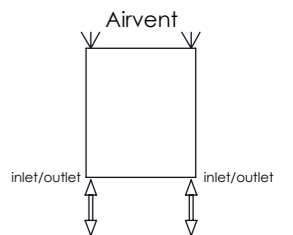



Fitting Position:



Vertical mount
 All Dimension are in mm
 Max.Working Pressure = 10 Bar
 Max.Working Temperature=95° C
 Inlet / Outlet : 1/2" BSP
 Fuel : E/H/D

Installation Accesories:

-  x4
-  x4
-  x4
-  x4
-  x4
-  x1

