

# ARAT E14-6060

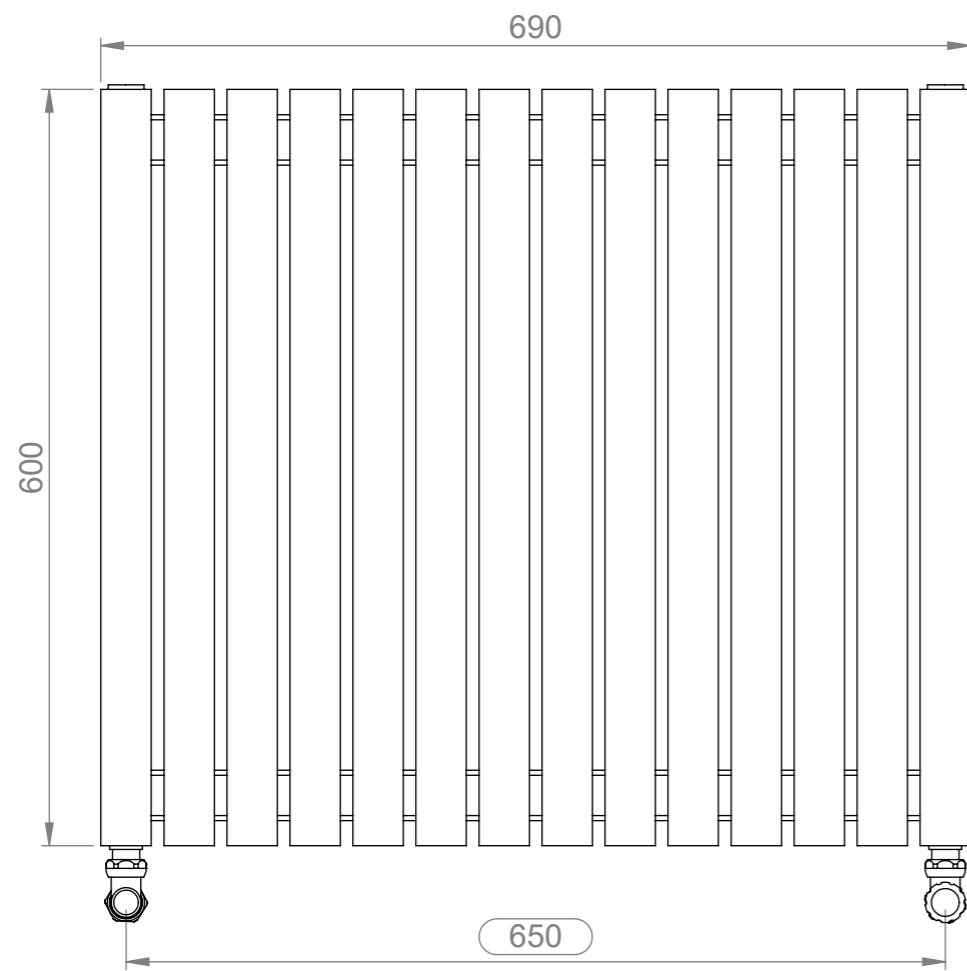

Front View

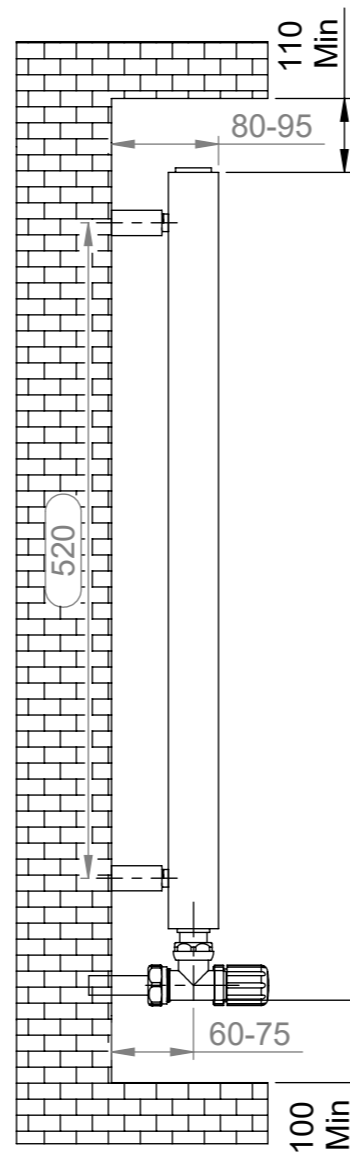

Side View

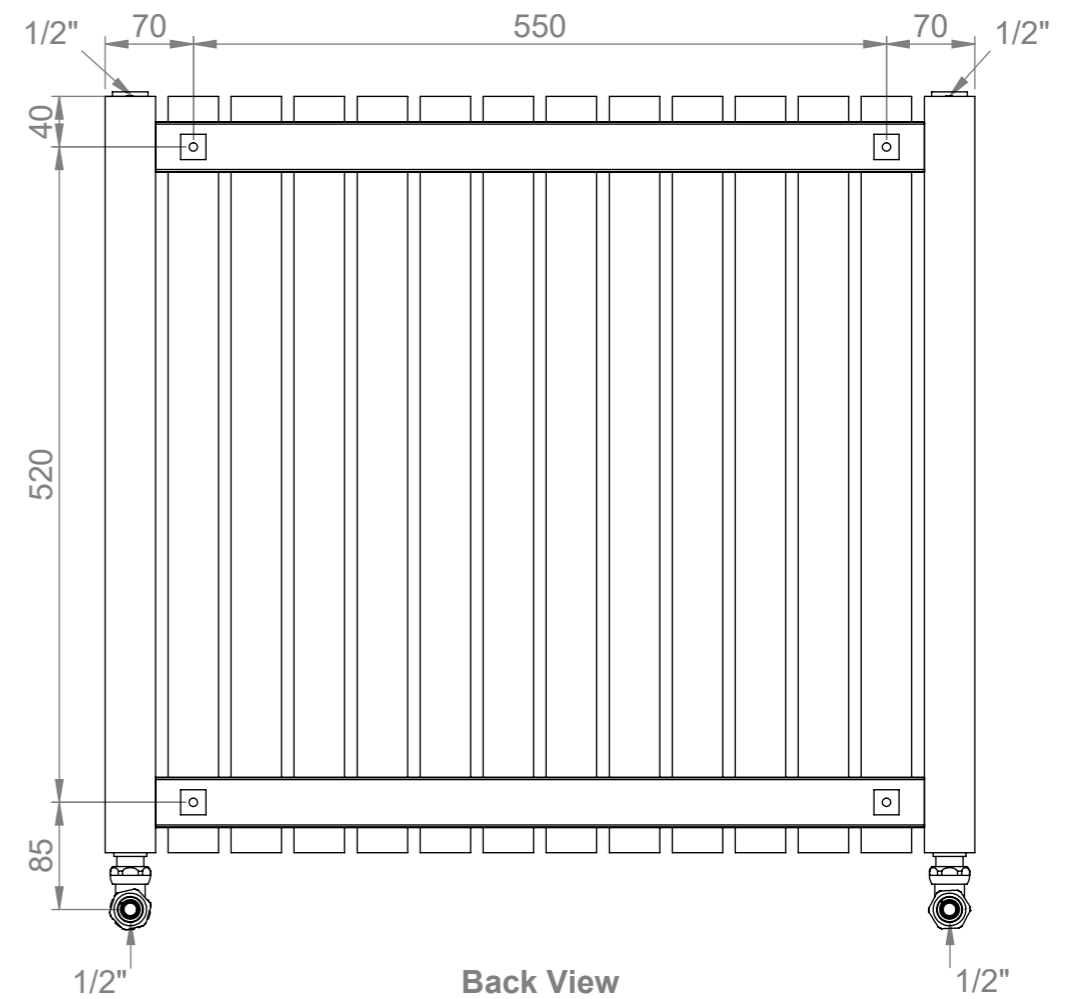

Back View

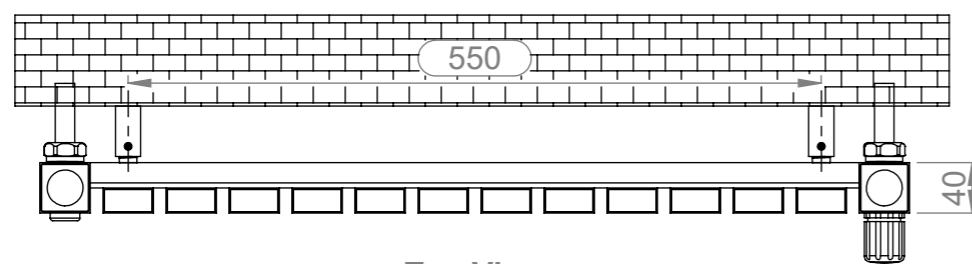

Top View

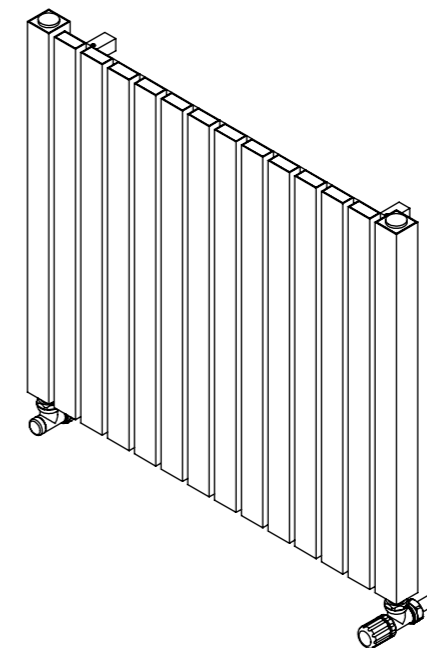



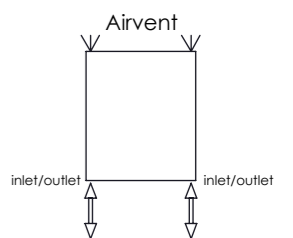



## Fitting Position:

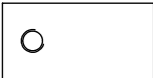

Vertical mount  
 All Dimension are in mm  
 Max.Working Pressure = 10 Bar  
 Max.Working Temperature=95° C  
 Inlet / Outlet : 1/2" BSP  
 Fuel : E/H/D

## Installation Accesories:

-  x4
-  x4
-  x4
-  x4
-  x4
-  x1

