

BOLERO-3

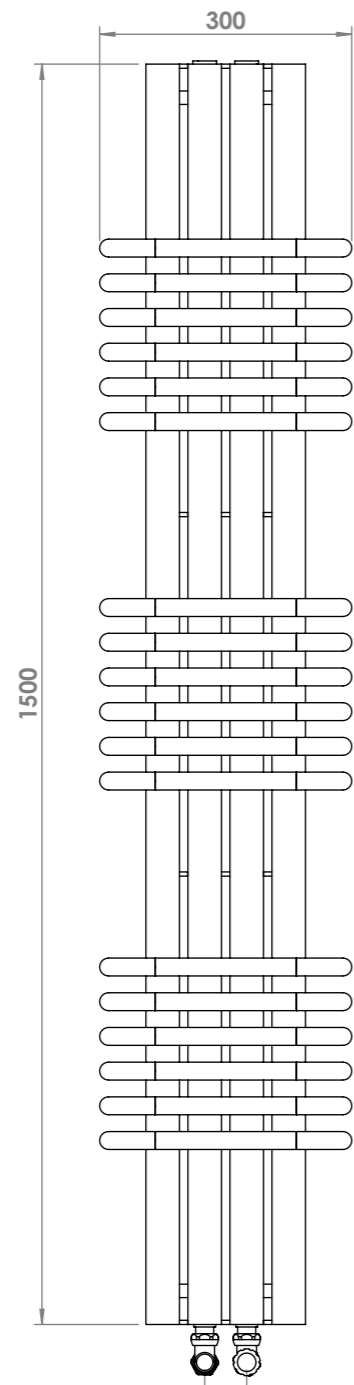

Front View

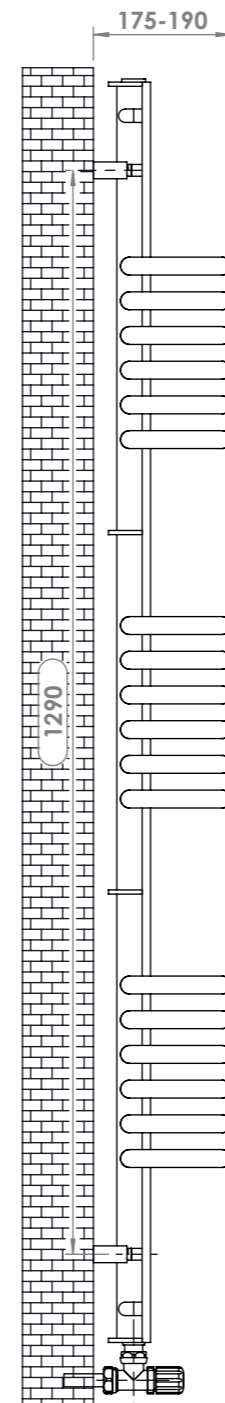

Side View

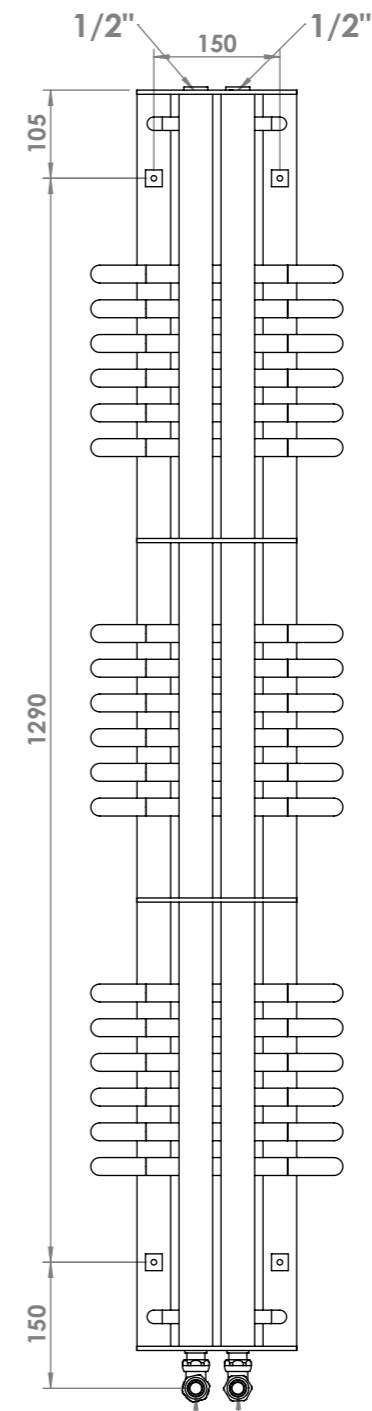



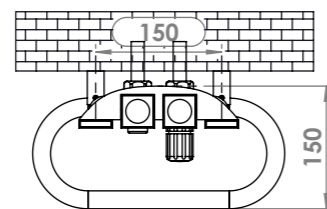
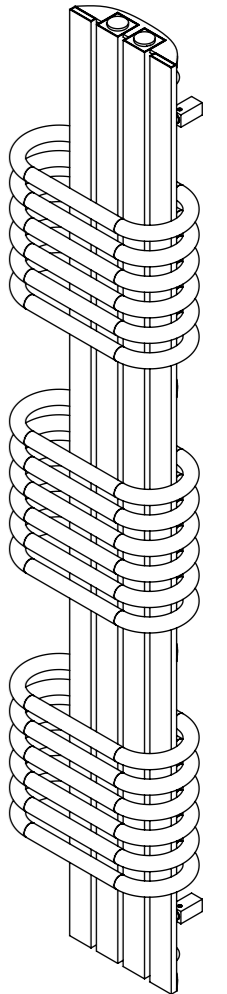

Back View

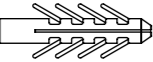

Top View

Installation Accesories:

- | | | | |
|---|----|---|----|
|  | x4 |  | x4 |
|  | x4 |  | x4 |
|  | x4 |  | x1 |

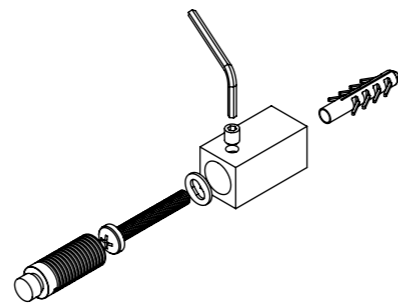

Fitting Position:

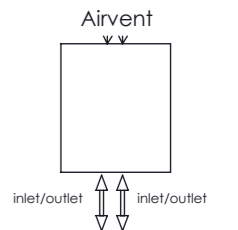

All Dimension are in mm
 Max.Working Pressure = 10 Bar
 Max.Working Temperature=95° C
 Inlet / Outlet : 1/2" BSP