

**Calder 508-5  
CCK-HE150**

REVISIONS				
ZONE	REV.	DESCRIPTION	DATE	APPROVED
	00	AÇIKLAMA	01.01.2011	ONAYLAYAN

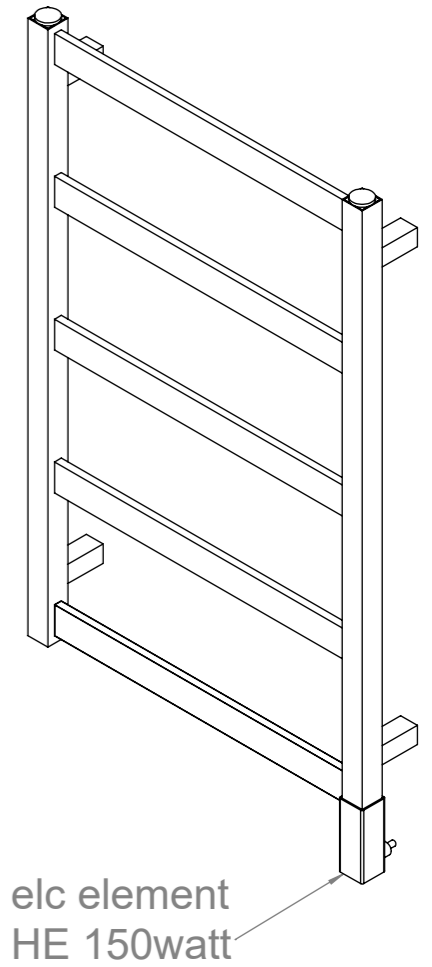

**Installation Accesories:**

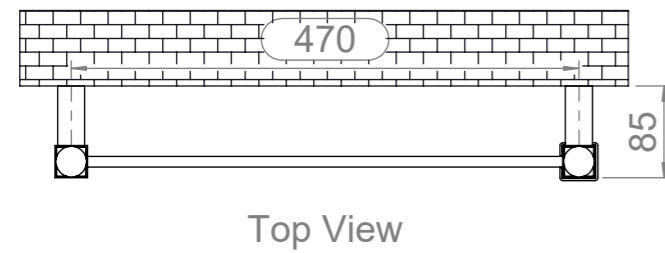
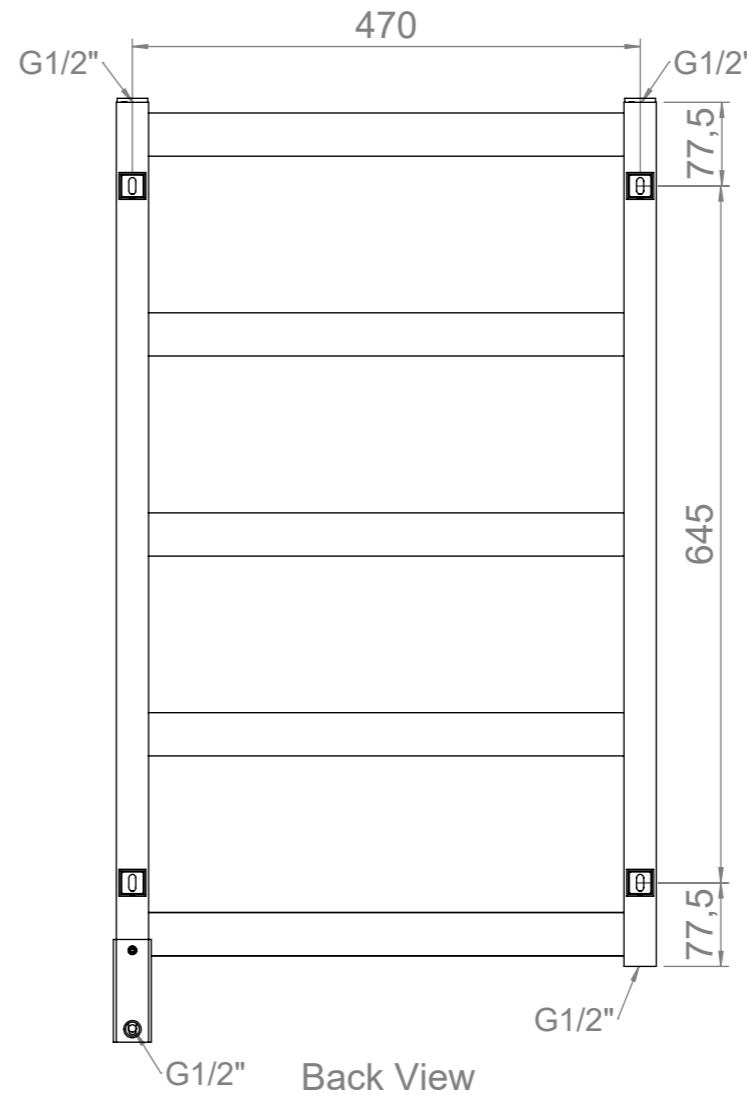
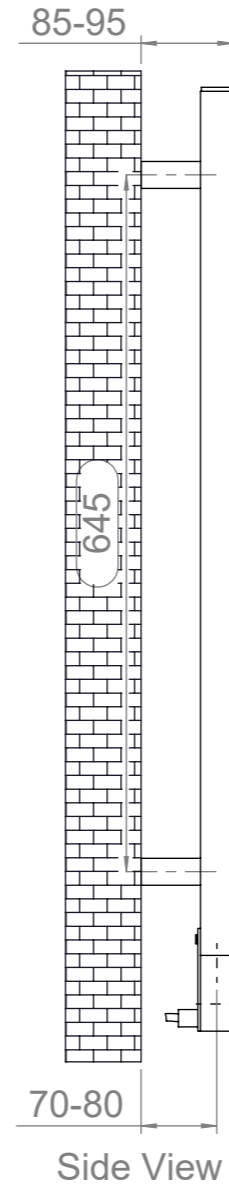
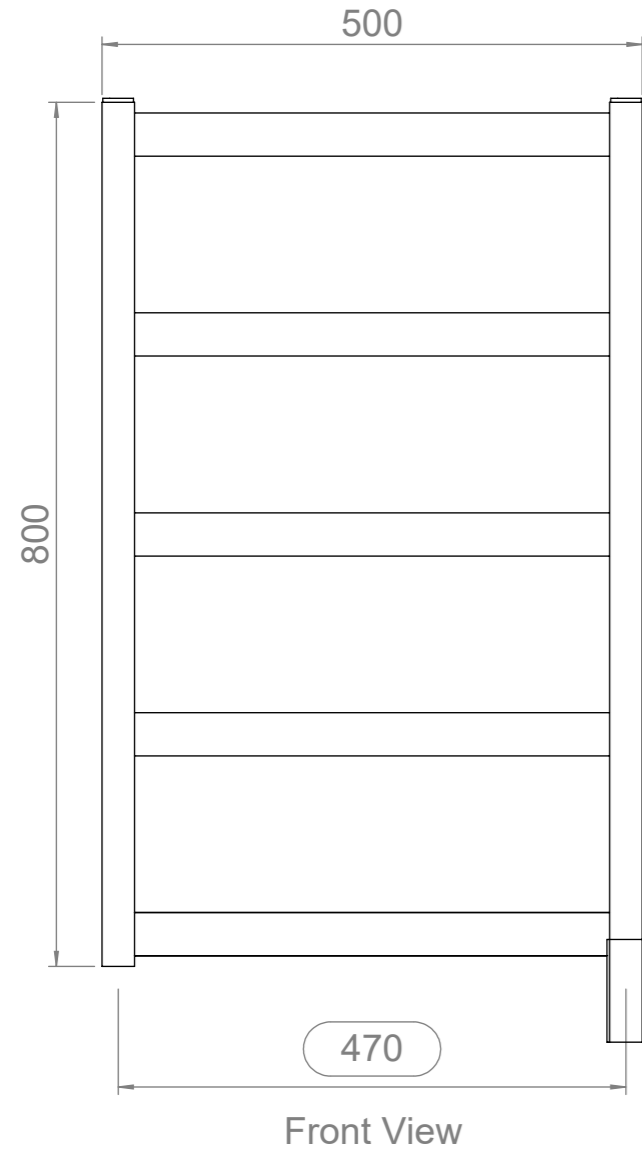
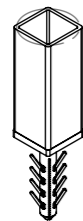
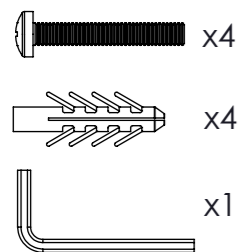

**Fitting Position:**

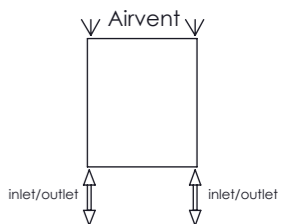

All Dimension are in mm  
Max.Working Pressure = 10 Bar  
Max.Working Temperature=95° C  
Inlet / Outlet : 1/2" BSP