

CombeT 15-L

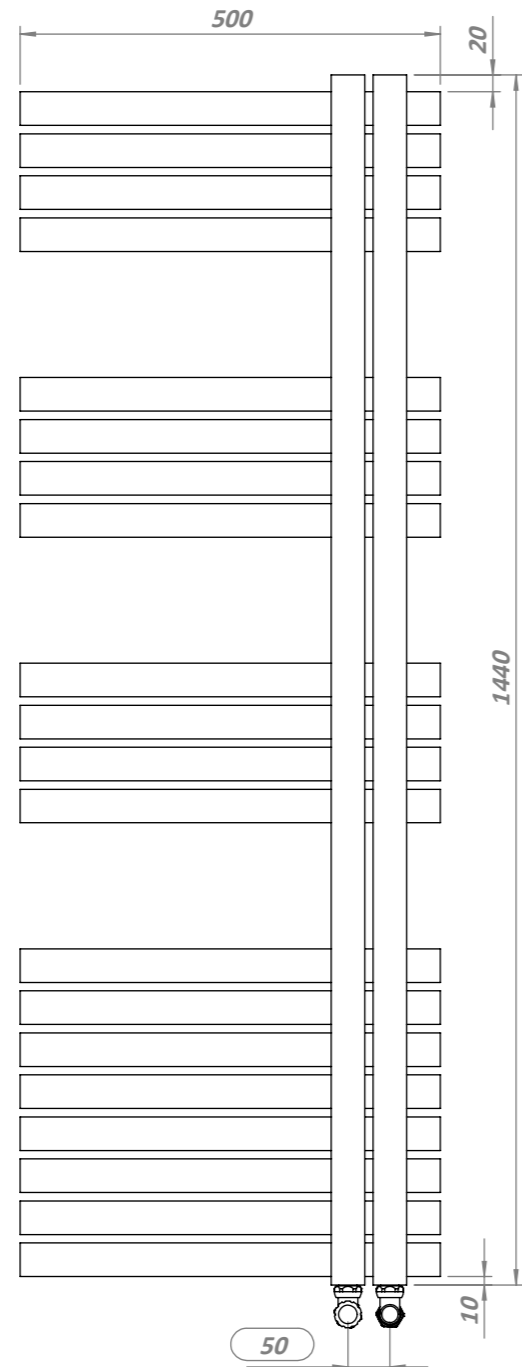

Front View

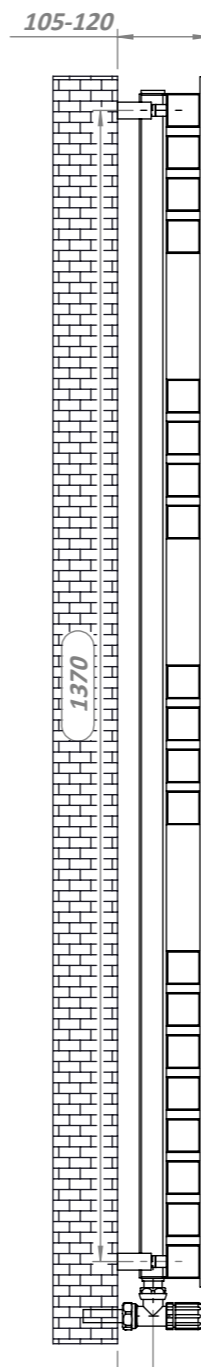

Side View

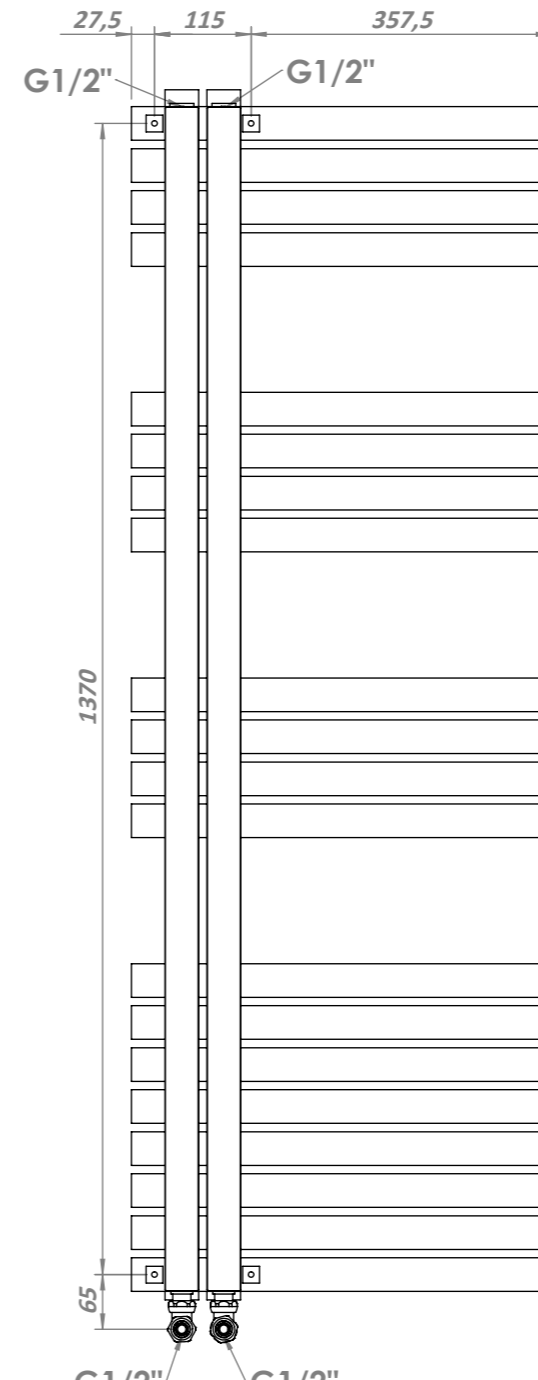

G1/2" G1/2"



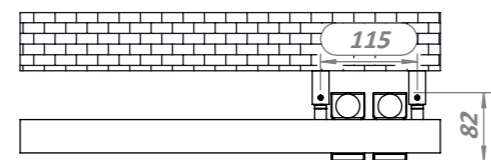

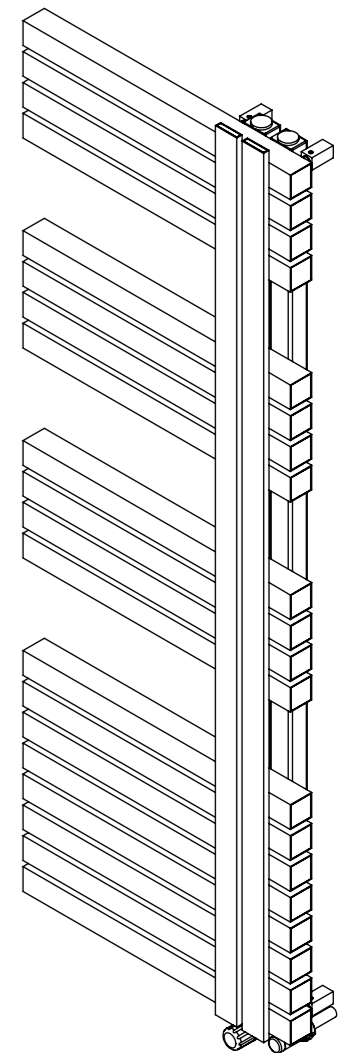

Back View



Top View



Installation Accesories:

- | | | | |
|-------------------------------------------------------------------------------------|----|-------------------------------------------------------------------------------------|----|
|  | x4 |  | x4 |
|  | x4 |  | x4 |
|  | x4 |  | x1 |

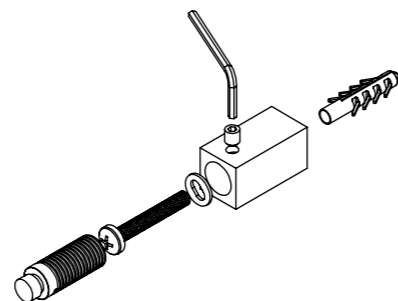

Fitting Position:

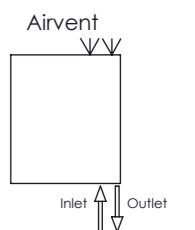

All Dimension are in mm
 Max.Working Pressure = 10 Bar
 Max.Working Temperature=95° C
 Inlet / Outlet : 1/2" BSP