

; U`]dc`]!&

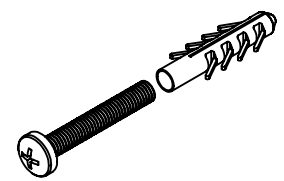

5WVWggcf]Yg

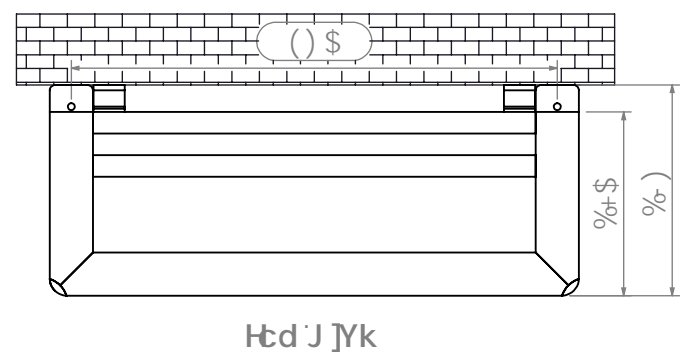
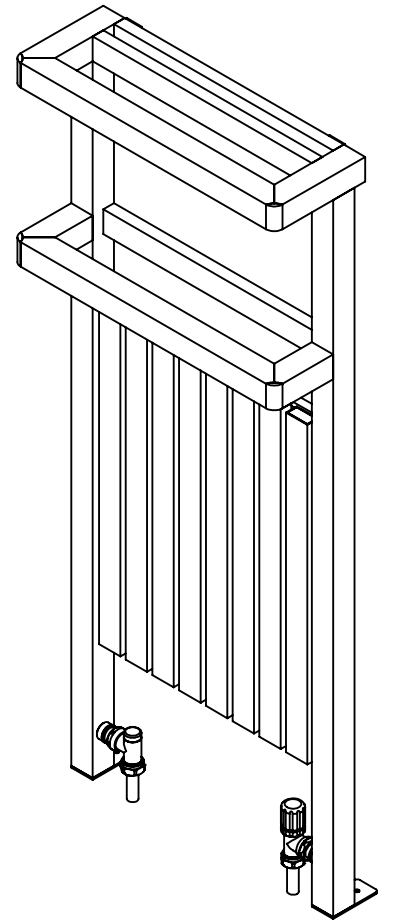
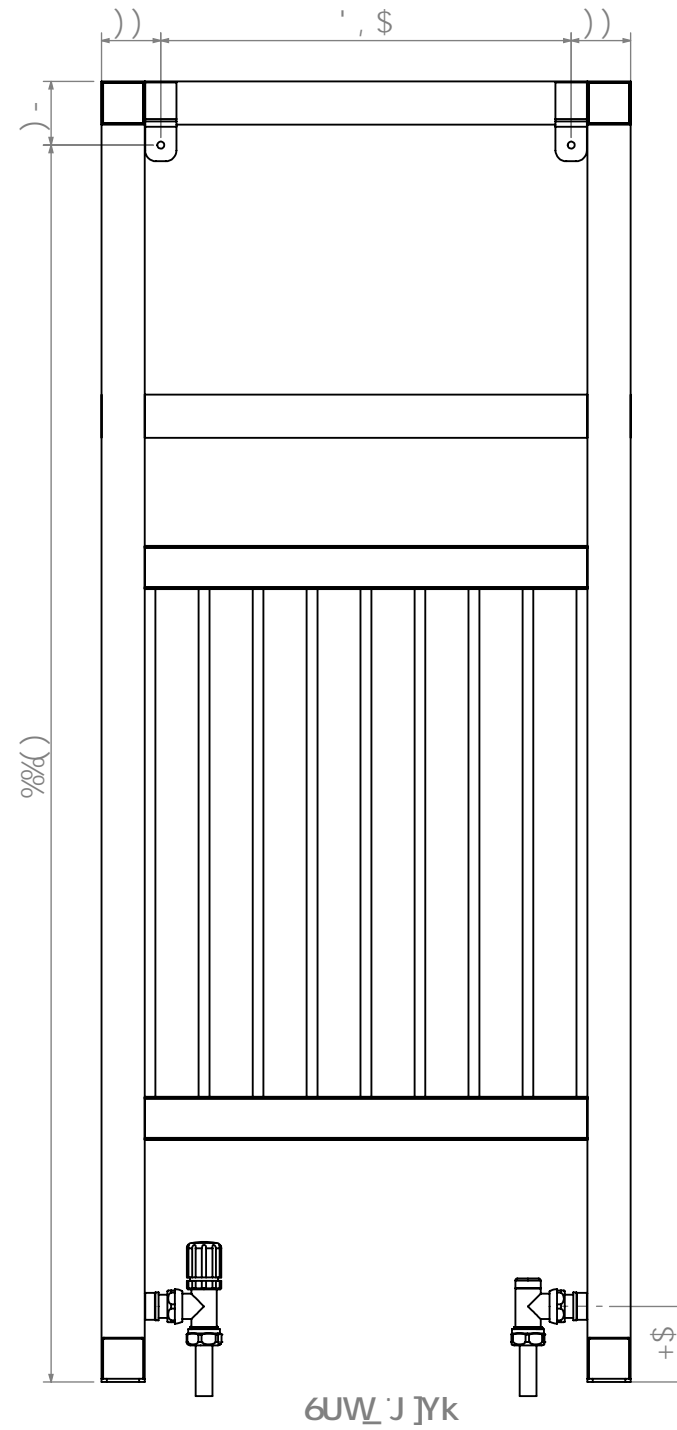
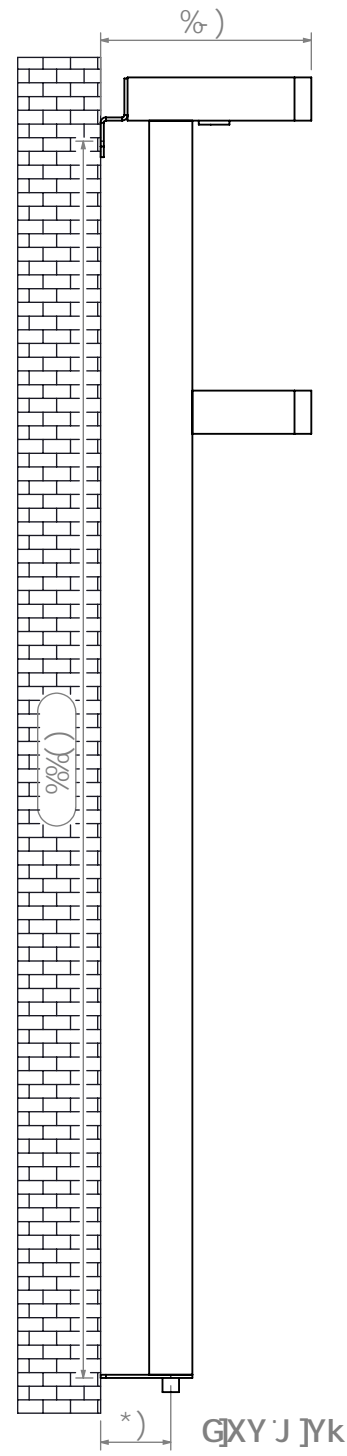
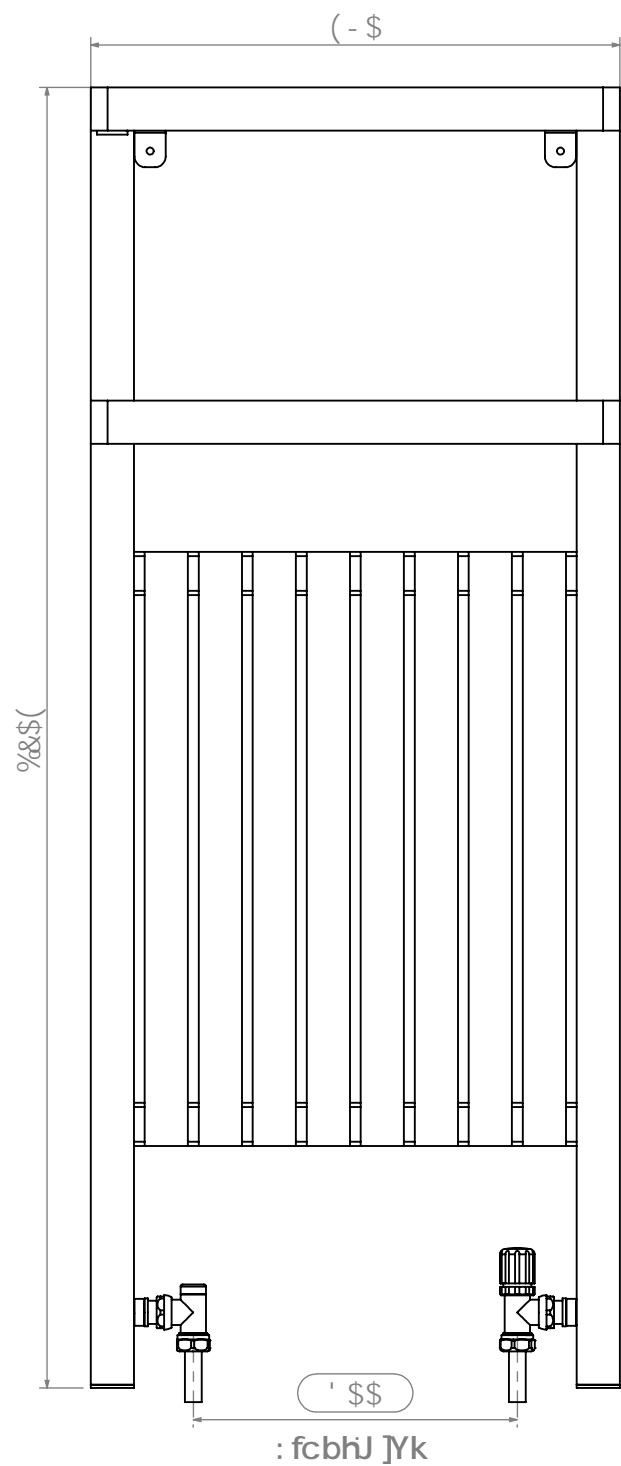
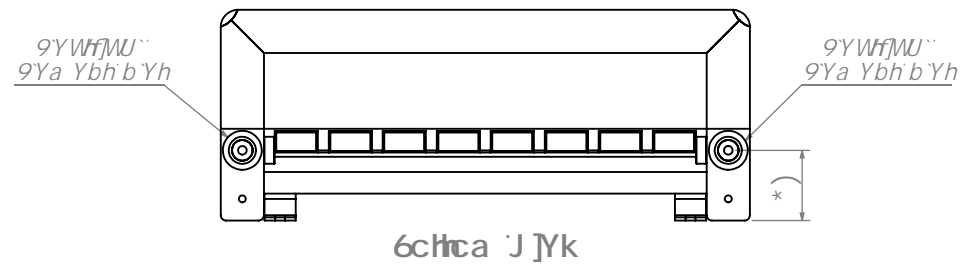

1(



1(

Di a V]b['Dcghcb.'

5]j Ybh^

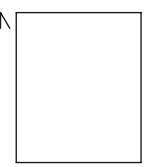

bYhcl hYh

X^!cBaA [] c
 Oe]Aa ^) .a} .Ae^/A {
 T aeEY [] a *AU!^.. ^!KFEAae
 T aeEY [] a *A/^\] ^!ae ^!KAI »AO
 Q] ^cAU c^oAKFEAYOUU
 Ø ^!KOEED