

MERIDYEN 100

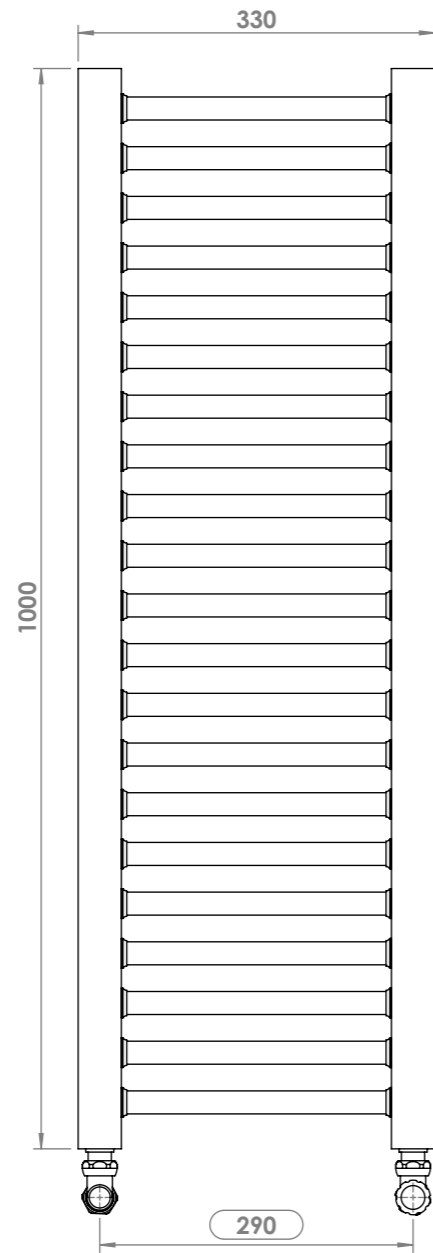

Front View

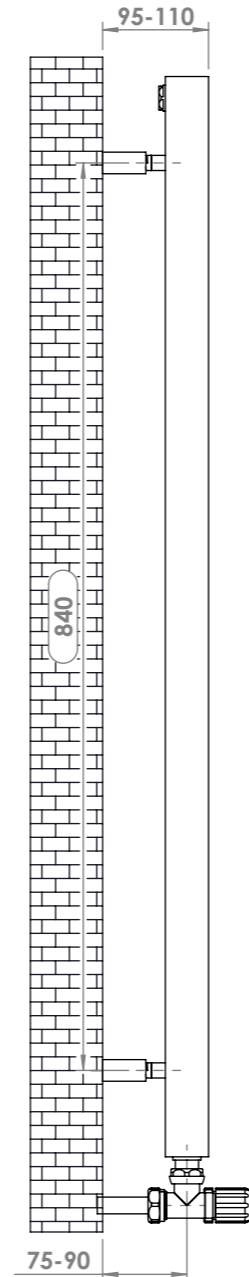

Side View

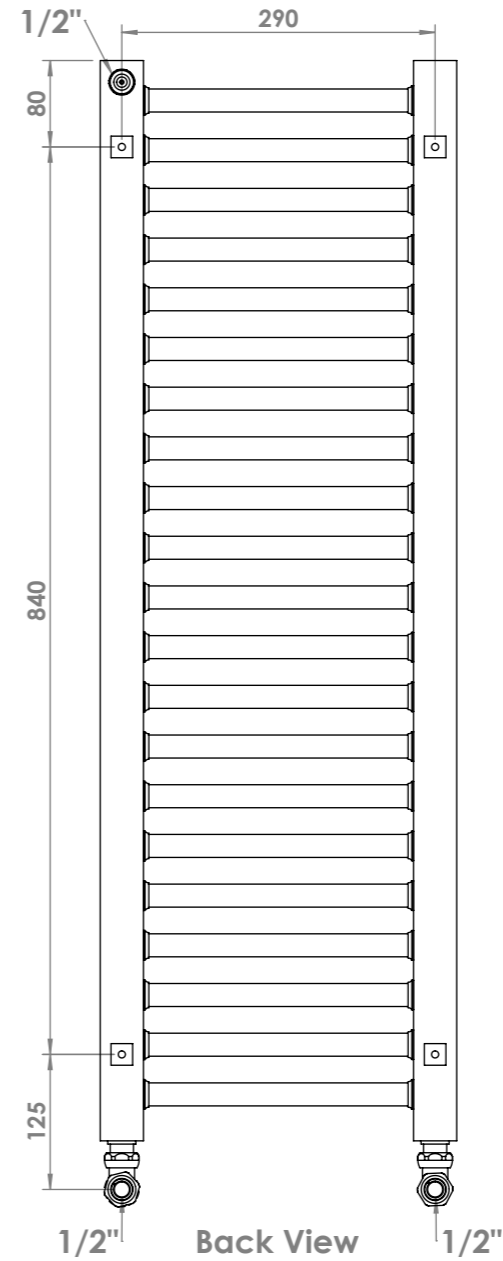



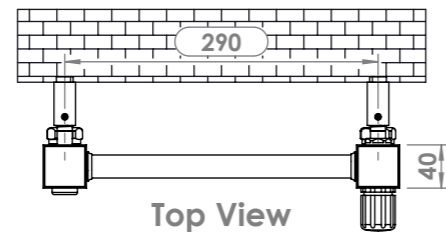
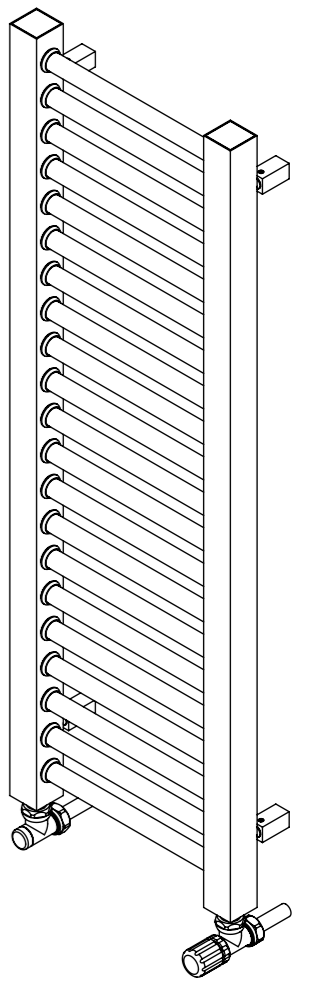



Back View



Top View

Installation Accesories:

- | | | | |
|---|----|---|----|
|  | x4 |  | x4 |
|  | x4 |  | x4 |
|  | x4 |  | x1 |

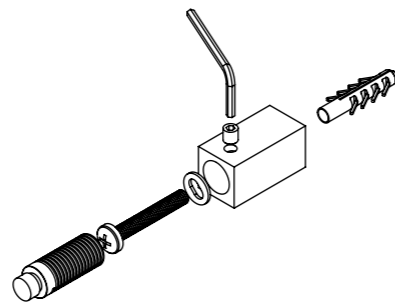

Fitting Position:

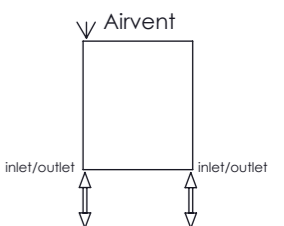

All Dimension are in mm
 Max.Working Pressure = 10 Bar
 Max.Working Temperature=95° C
 Inlet / Outlet : 1/2" BSP

A 9F -8M9B %Q \$

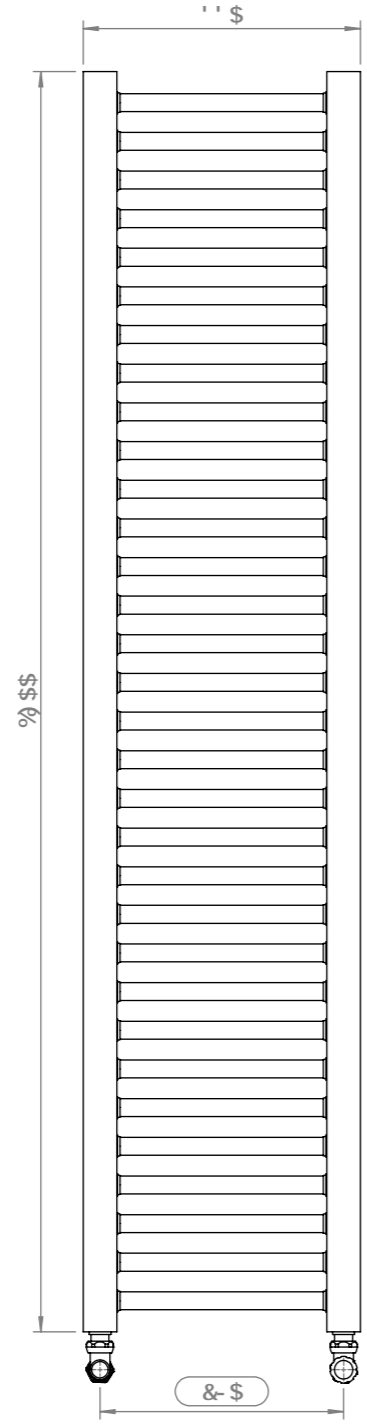

: fcbhJ JYk

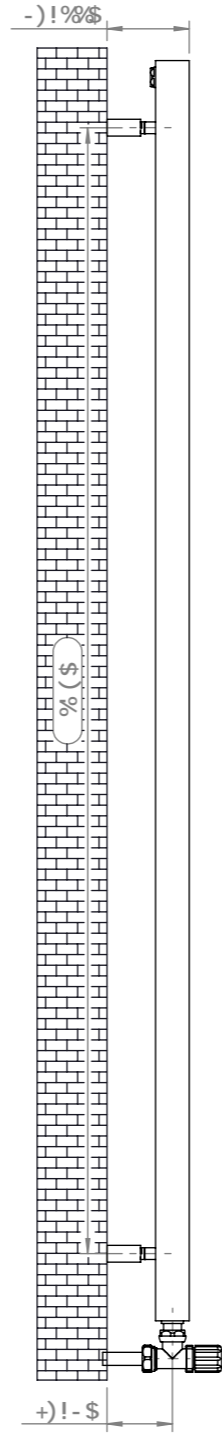

GjXY' J Yk

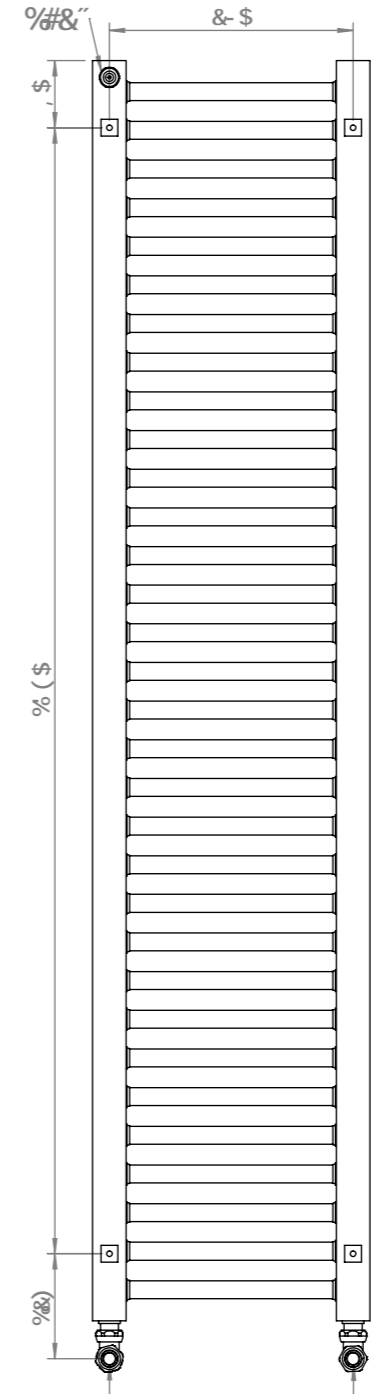



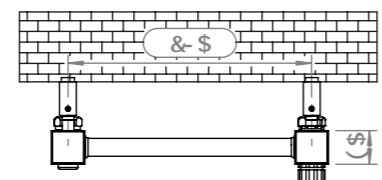
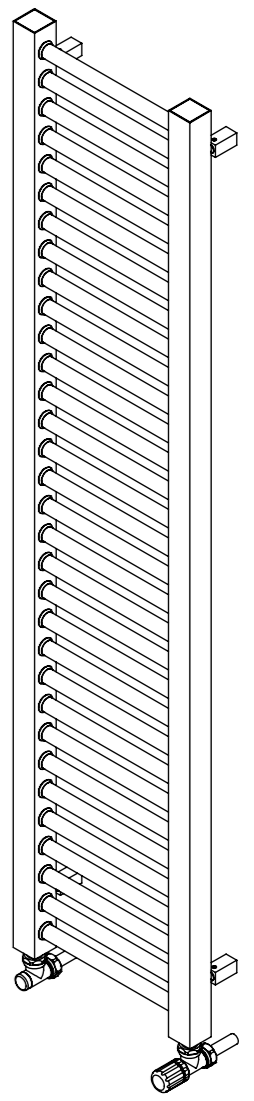



%#&'' 6UW' J Yk %'#&''



Htd' J Yk

bgU~UHcb'5VWYgc fJYg'

-  1 (
-  1 (
-  1 (
-  1 (
-  1 (
-  1 %

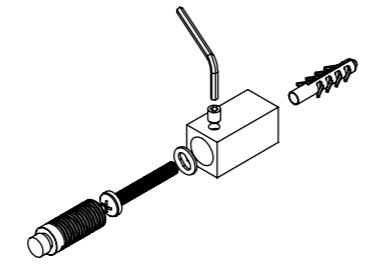

: Hb['Dcgh]cb.

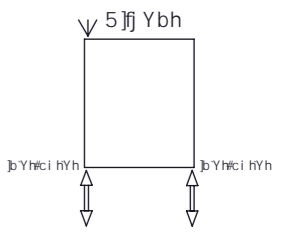





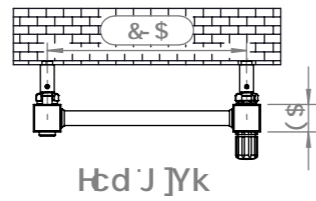
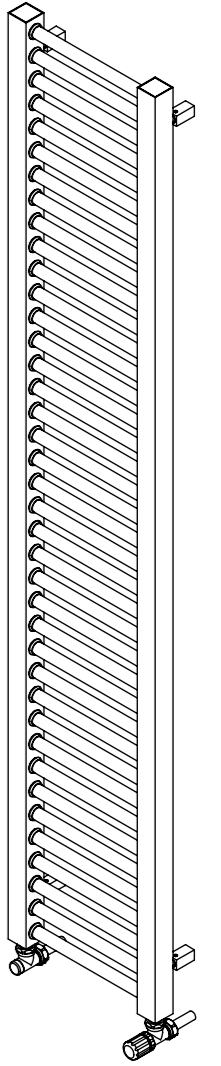
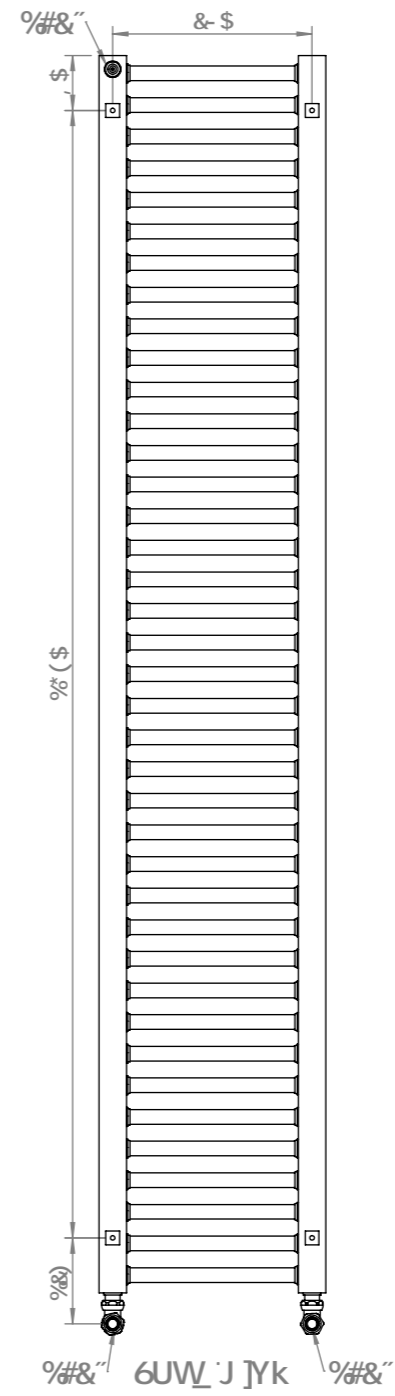
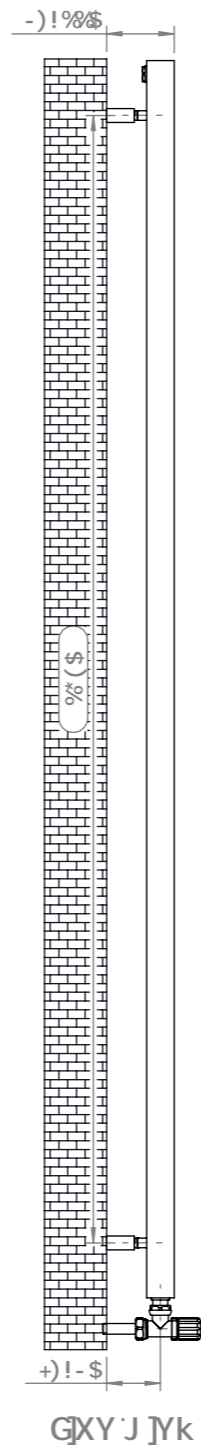
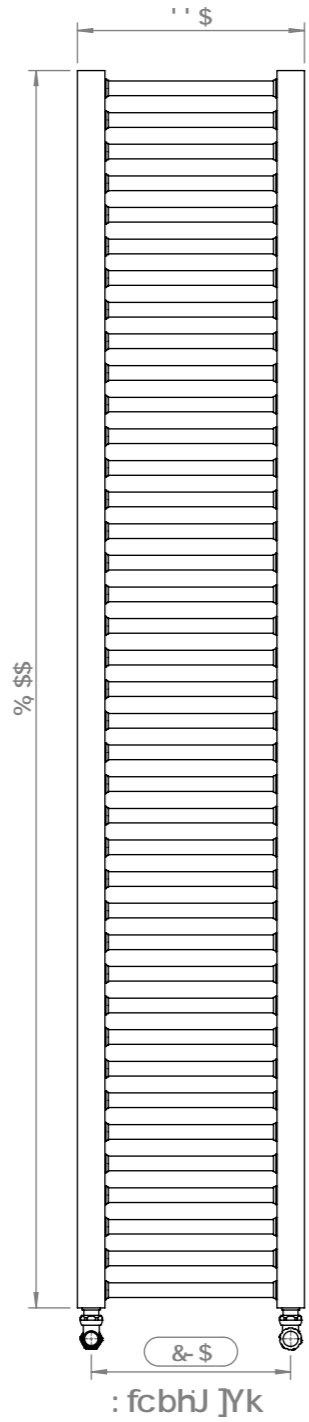

0H/AÖa ^} • q } Ae^A Ä {
 T æËY [\ ä * ÄU! ^•• ! ^M/F € /Oæ
 T æËY [\ ä * Ä^ \] ! æ ! ^MJI » Ö
 Q | ^ Ö ÄU d ^ Ö M F E A Ö U U

A 9F 8MB % \$



~bqU`Uhcb'5WVWgc f]Yg`

- | | | | |
|---|-----|---|-----|
|  | 1 (|  | 1 (|
|  | 1 (|  | 1 (|
|  | 1 (|  | 1 % |

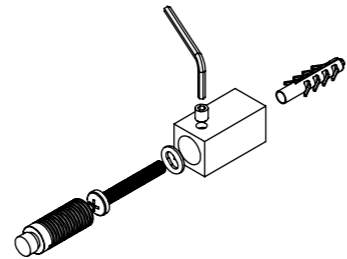

:]hb['Dcgh]cb.

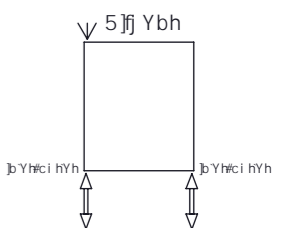



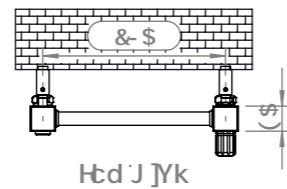
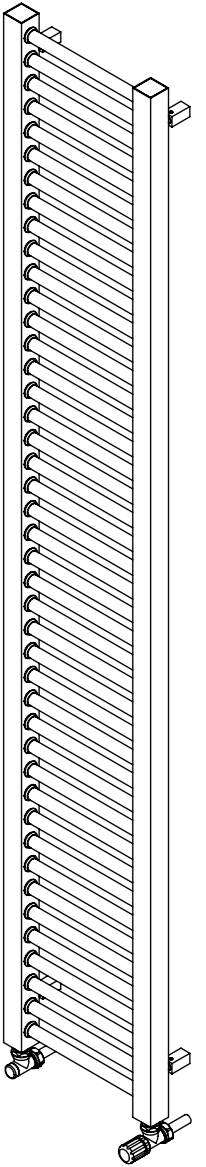
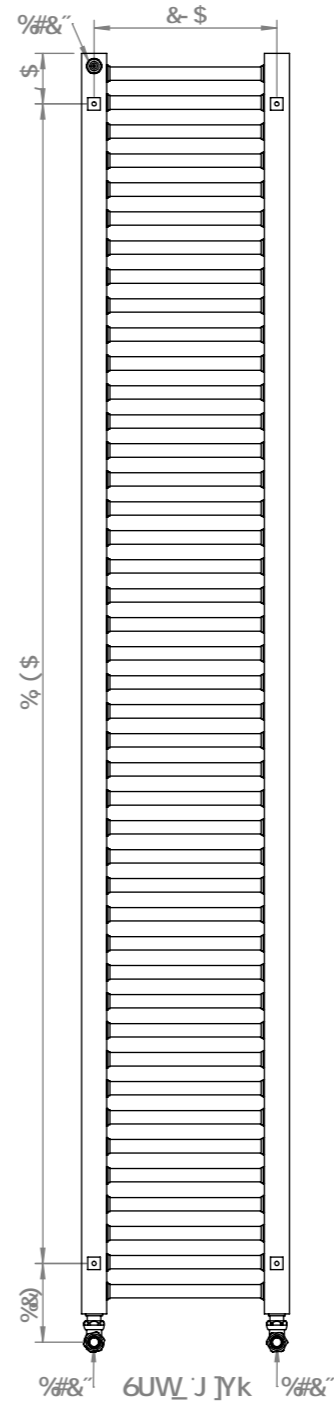
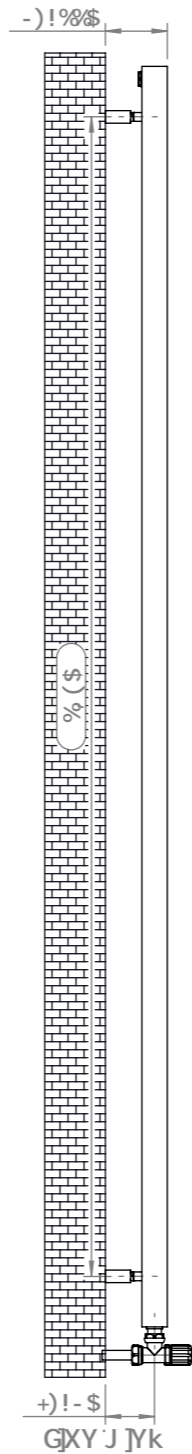
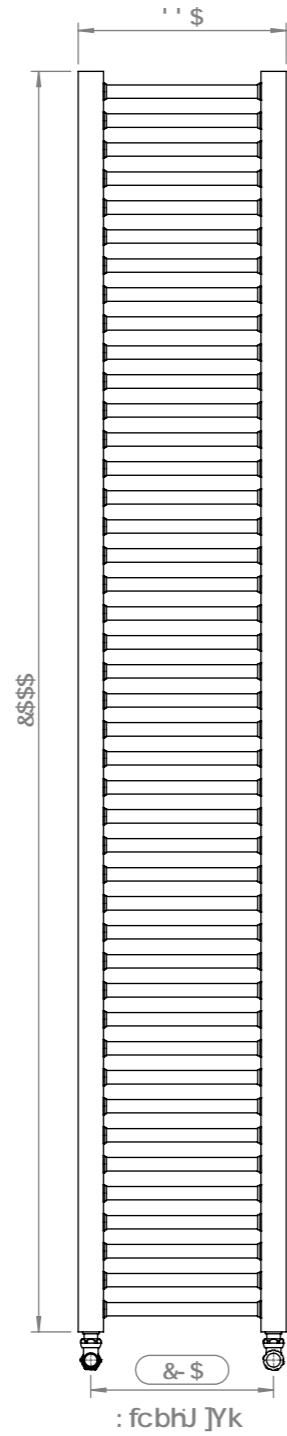

Oe/AÖa ^} • q } Ae^Aä Ä {
 T æËY [\ ä * ÄU!^•• !^M/F€'Oæ
 T æËY [\ ä * Ä^ {] |æ] ^Mj | »Ö
 Q | ^ÖU d^ ÄK BÄOUU

A 9F -8M9B'&\$\$

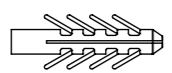

fbgU`Uhcb'5VWgcfJYg`

-  1 (
-  1 (
-  1 (
-  1 (
-  1 (
-  1 %

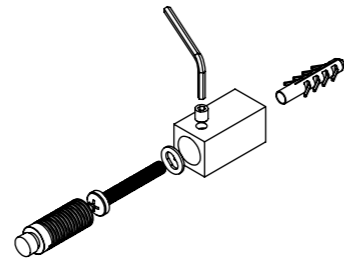

:]h[b 'Dcgl]cb.

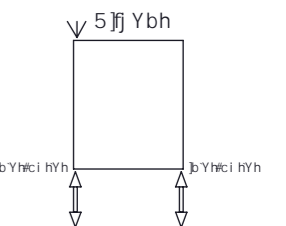

0H/Aa ^} • a } Ae ^/a A {
 T æEY [\ a * AU!^• !^M/E/Oæ
 T æEY [\ a * A^ {] !æ !^MJ! »O
 Q | ^OU d ^M/E/OUU