

Mystic E610-Rev01

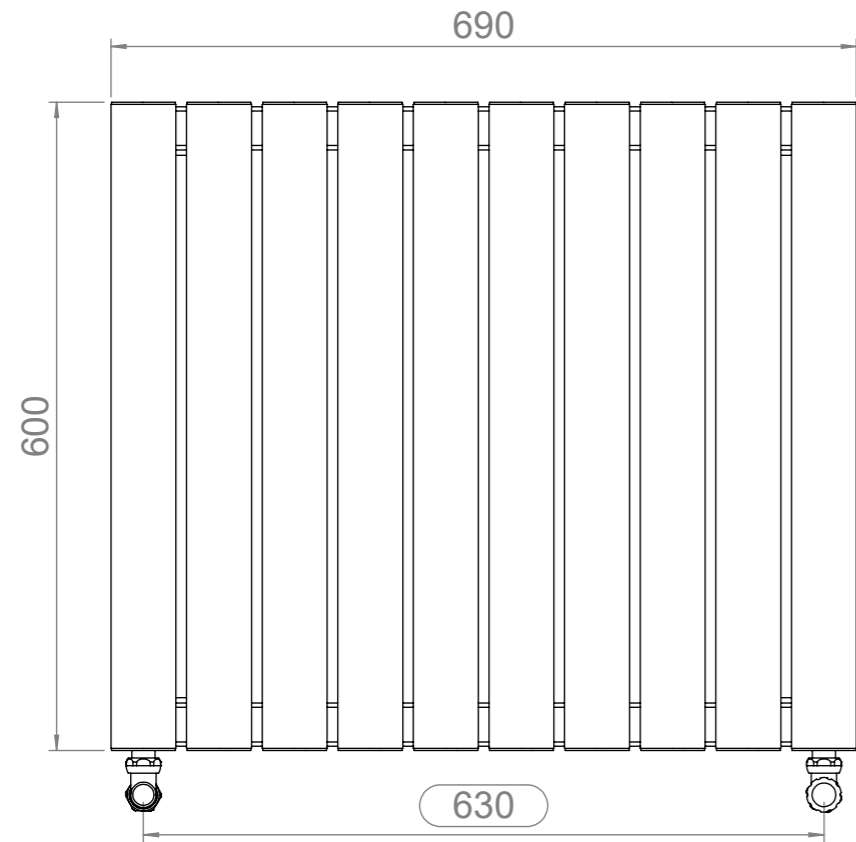

Front View

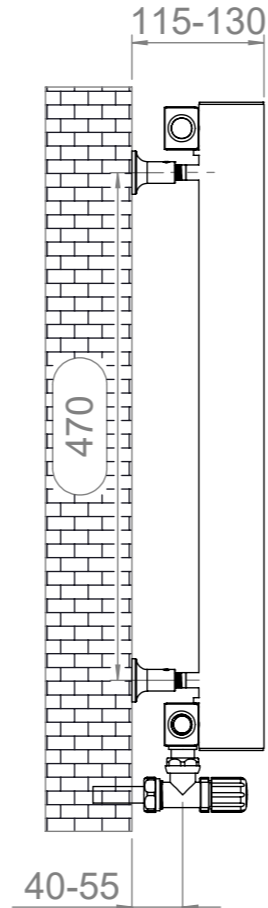

Side View

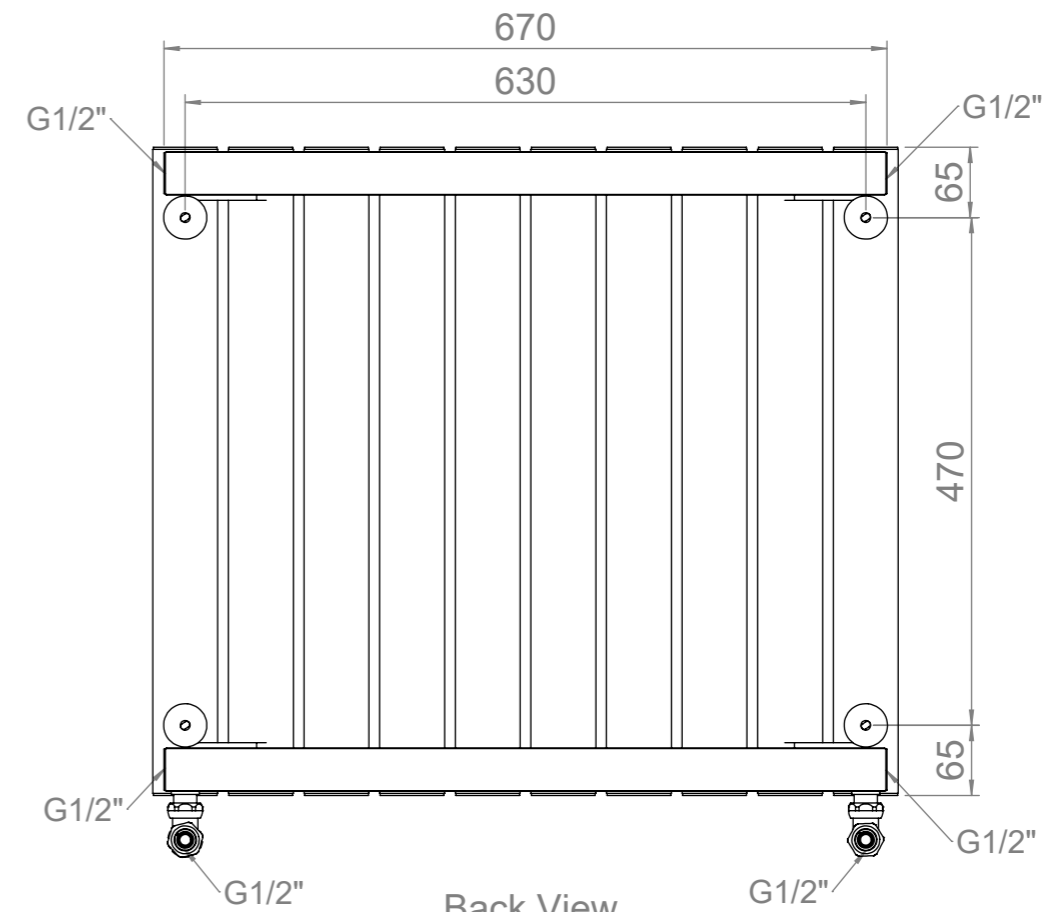



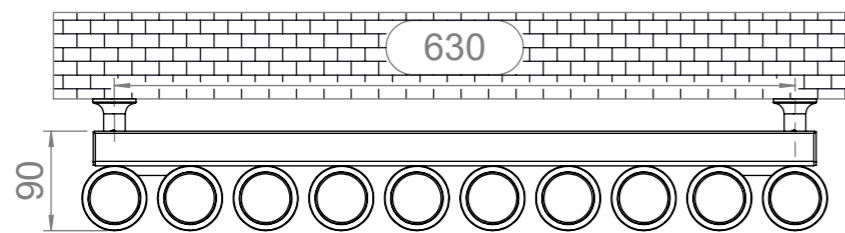

Back View

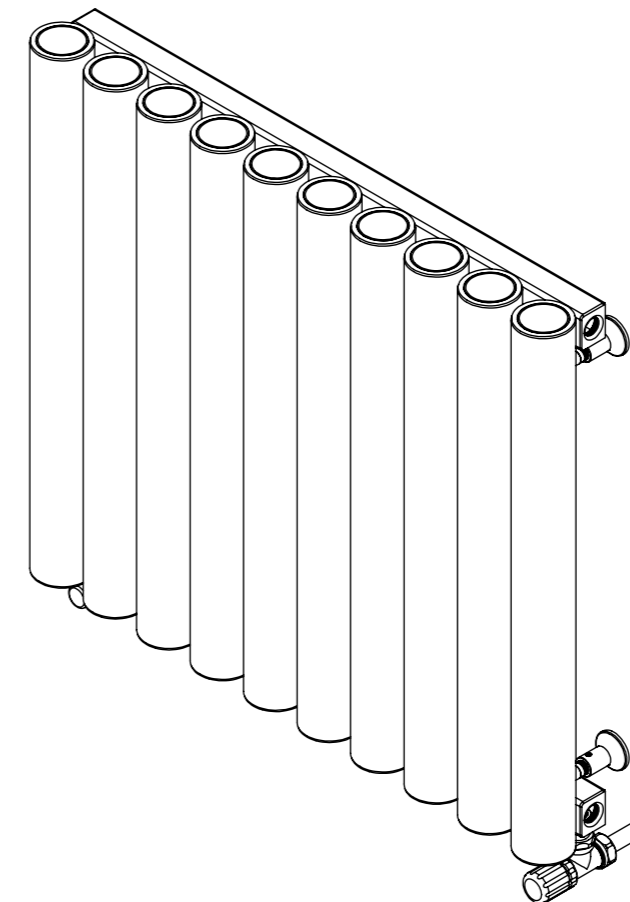

Top View

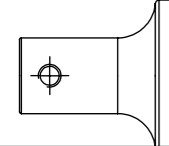
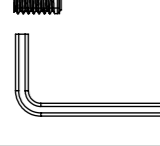

Installation Accesories:

- | | | | |
|---|----|---|----|
|  | x4 |  | x4 |
|  | x4 |  | x4 |
|  | x4 |  | x1 |

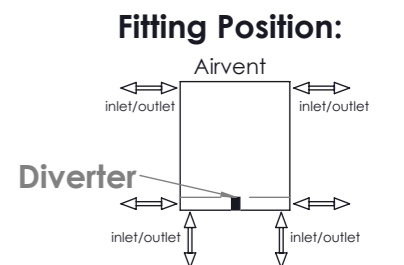
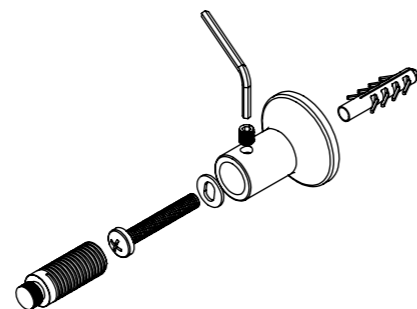

All Dimension are in mm
 Max.Working Pressure = 10 Bar
 Max.Working Temperature=95° C
 Inlet / Outlet : 1/2" BSP