

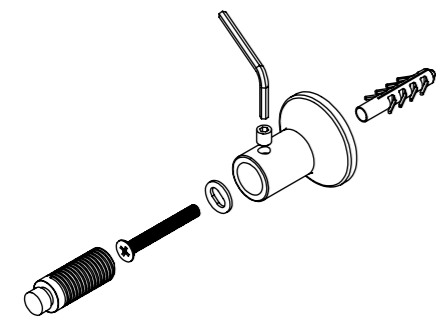

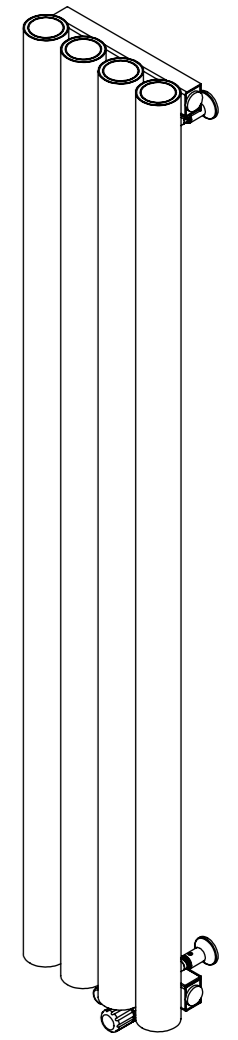

A MGH=7!9 % (

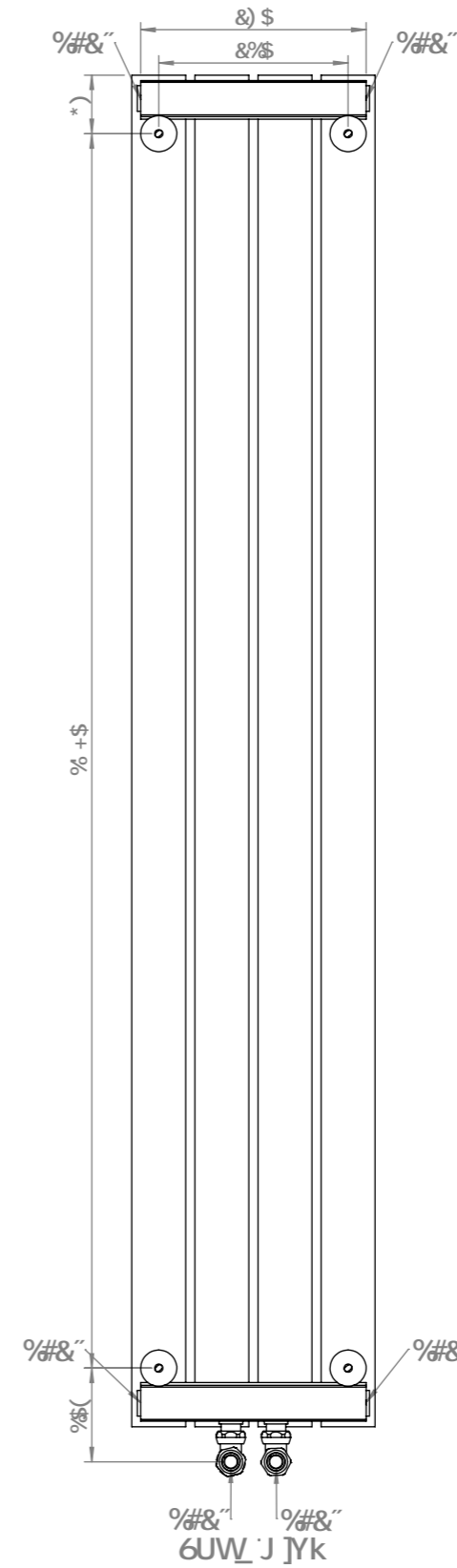
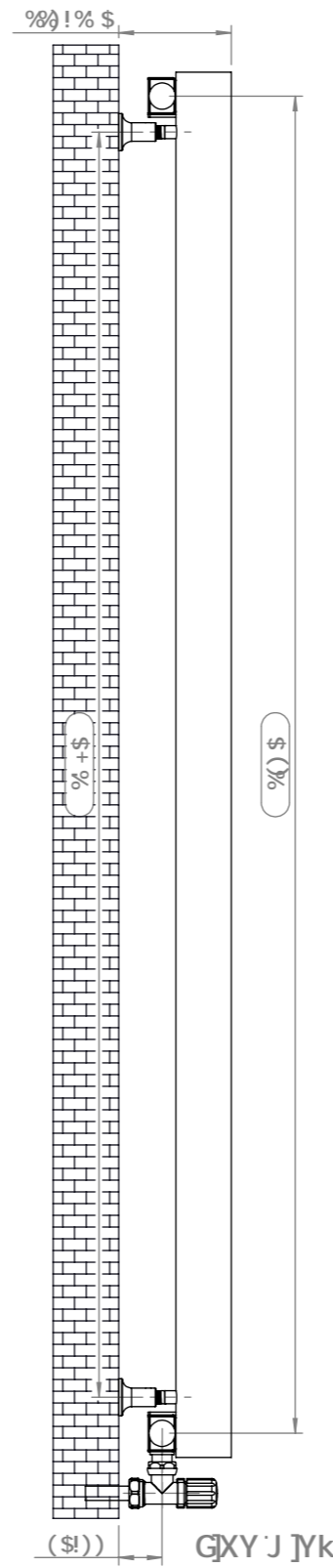
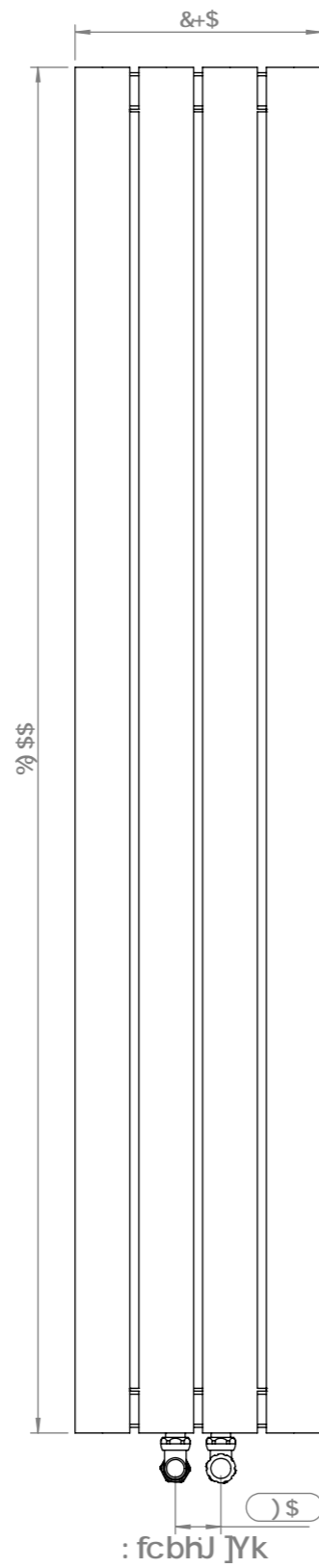

~bgtU~Uhjcb'5WVYgcflYg'

- | | | | |
|---|-----|---|-----|
|  | 1 (|  | 1 (|
|  | 1 (|  | 1 (|
|  | 1 (|  | 1 % |

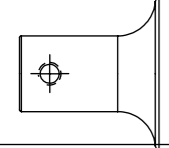
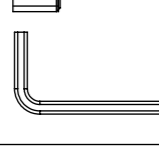
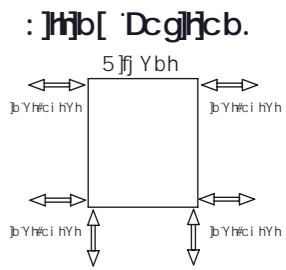
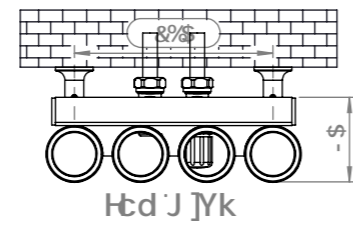





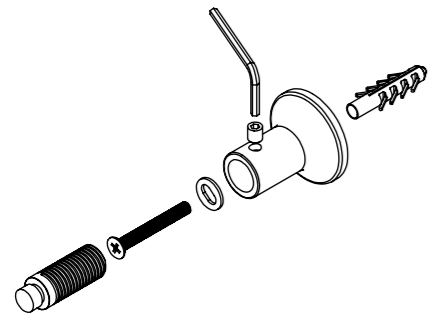
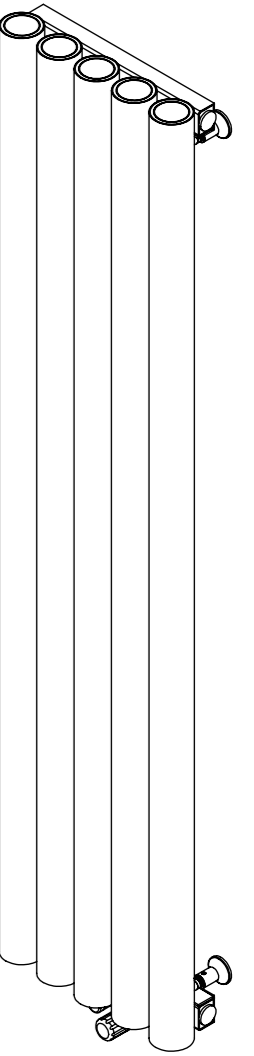
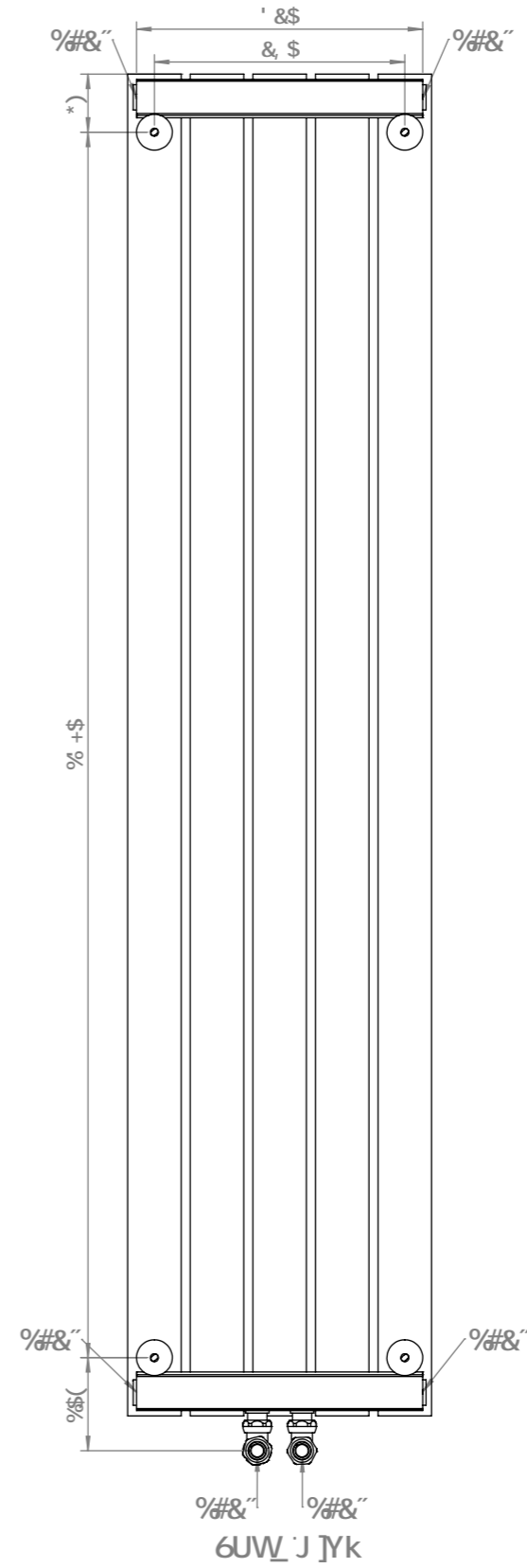
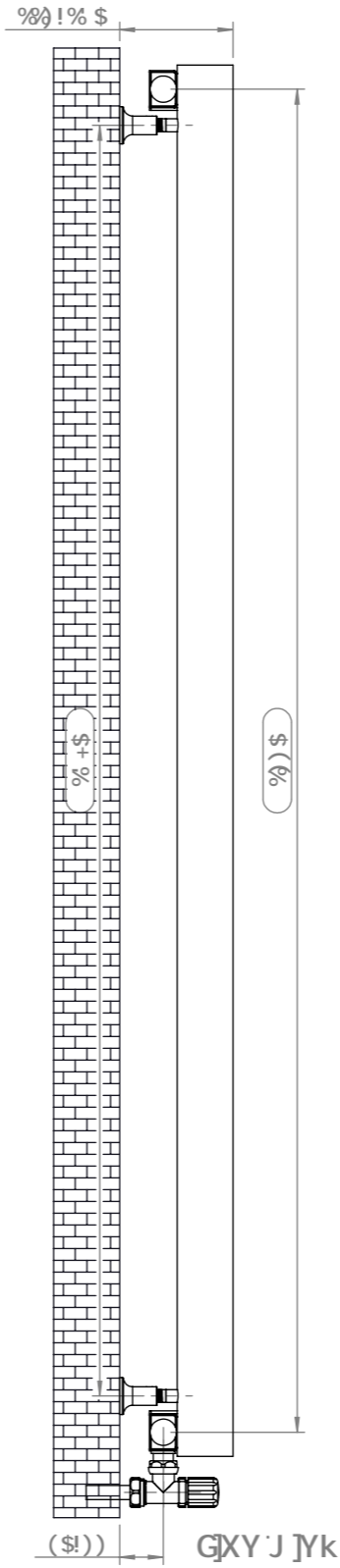
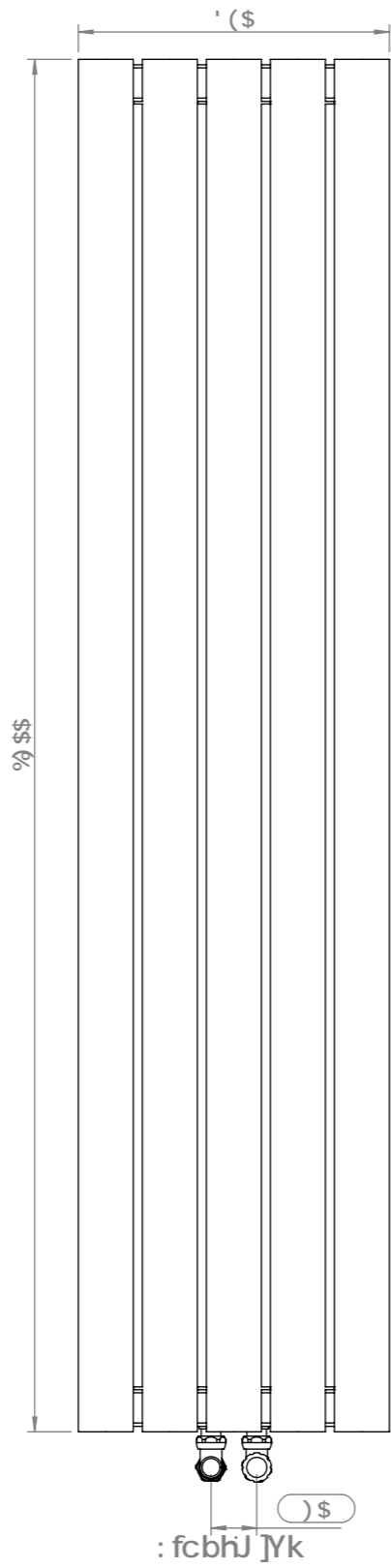

Q|/Öa ^} • a } Ae^/Ä Ä {
T æÉY [\ä * AU:•• \^AMF€Oæ
T æÉY [\ä * A^ {] |æ \^MU | »Ö
Q|/Öa q^ AMF€OAU

A MGH=7!9 %)



~bghU`Uhjcb'5WVYgc fJYg`

-  1 (
-  1 (
-  1 (
-  1 (
-  1 (
-  1 %

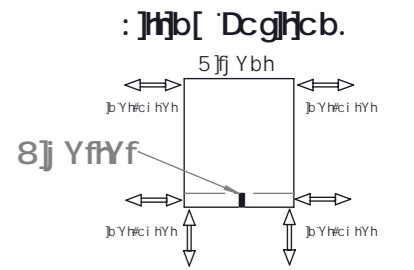
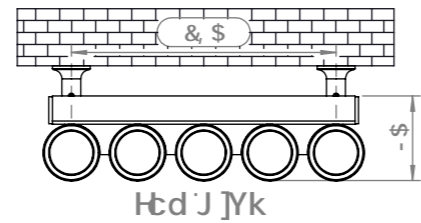

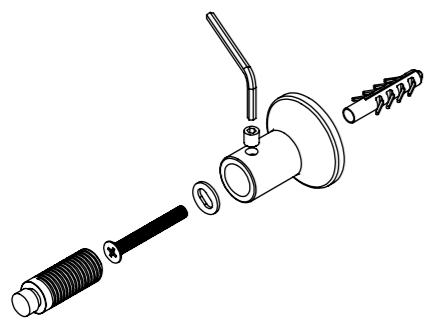
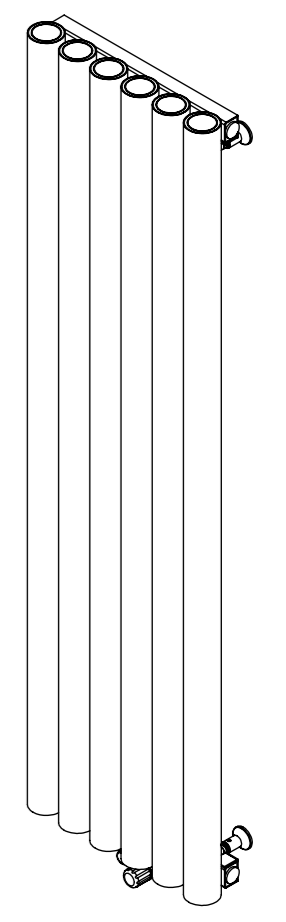
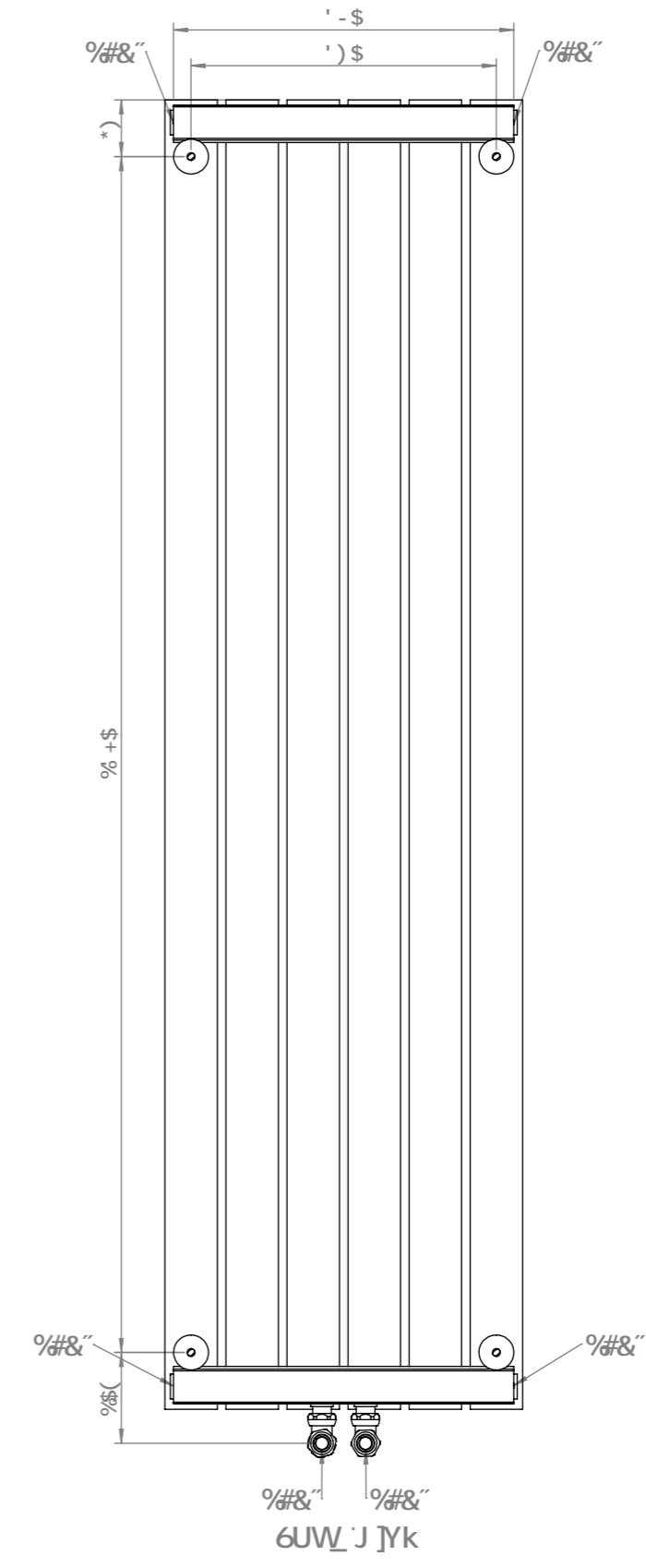
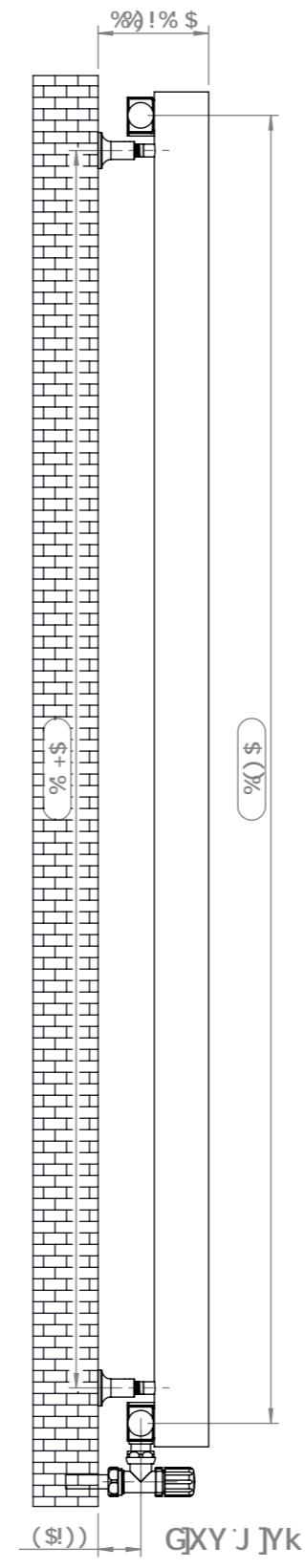
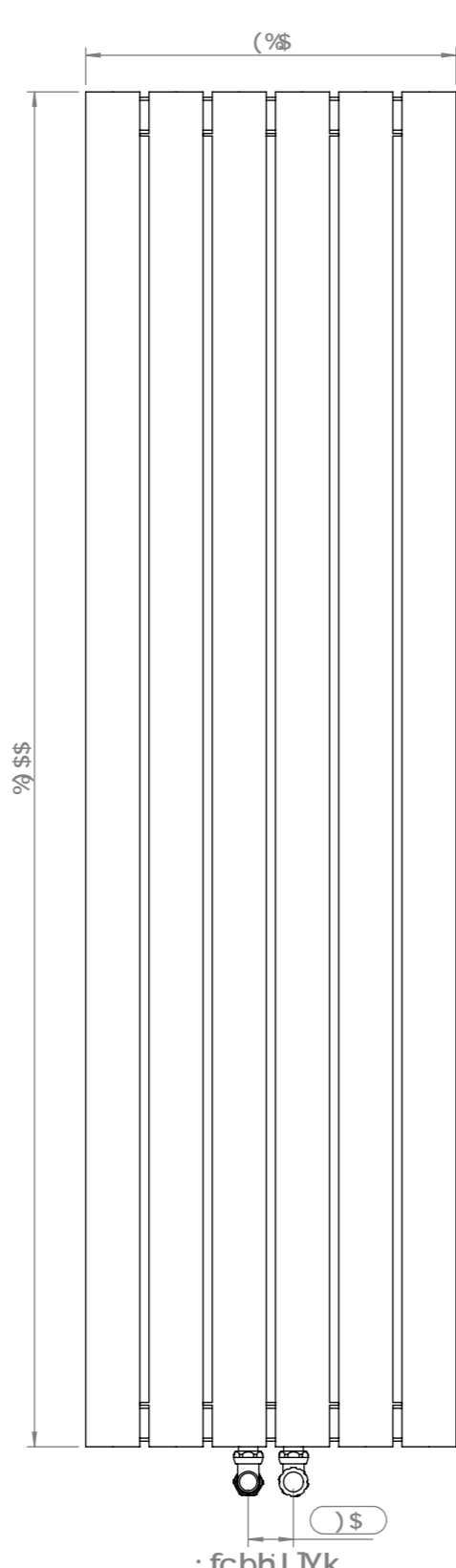

Q|/Öa ^} • a } Åe^/Å Å {
 T æÉY [\ ä * AU:•• ^ ^ ÅMÆ ÅÖæ
 T æÉY [\ ä * Å^ {] | æ j ^ M U j » Å
 Q | ^ Å U q ^ Å M F Å Ö U U

A MGH=7!9'9 *

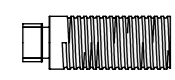
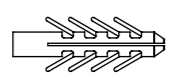

⊖gU`Uhcb'5WVYgc fJYg`

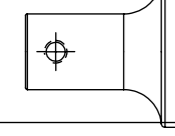
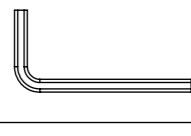
- | | | | |
|---|-----|---|-----|
|  | 1 (|  | 1 (|
|  | 1 (|  | 1 (|
|  | 1 (|  | 1 % |

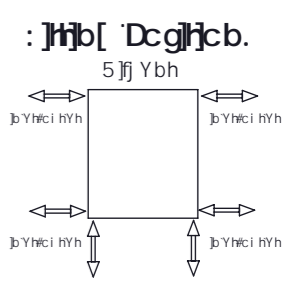
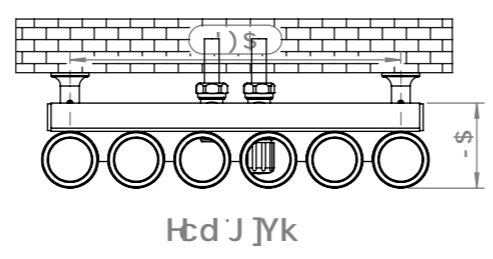

Qh/Oa ^} • a } Ae^/A {
T æEY [\ a * AU:•• ^ AMEAOæ
T æEY [\ a * A^ {] |æ | ^MU | »O
Q | ^ AU q ^ AMEAOUU

A MGH=7!9 %,

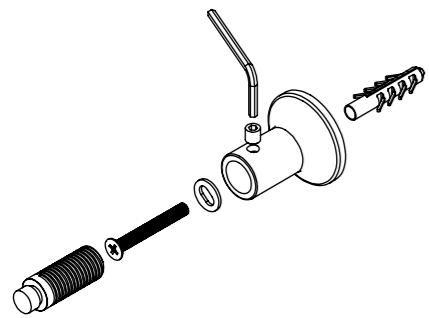
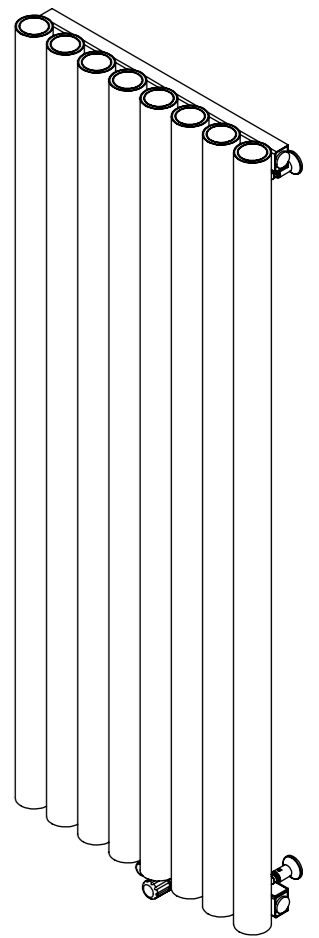
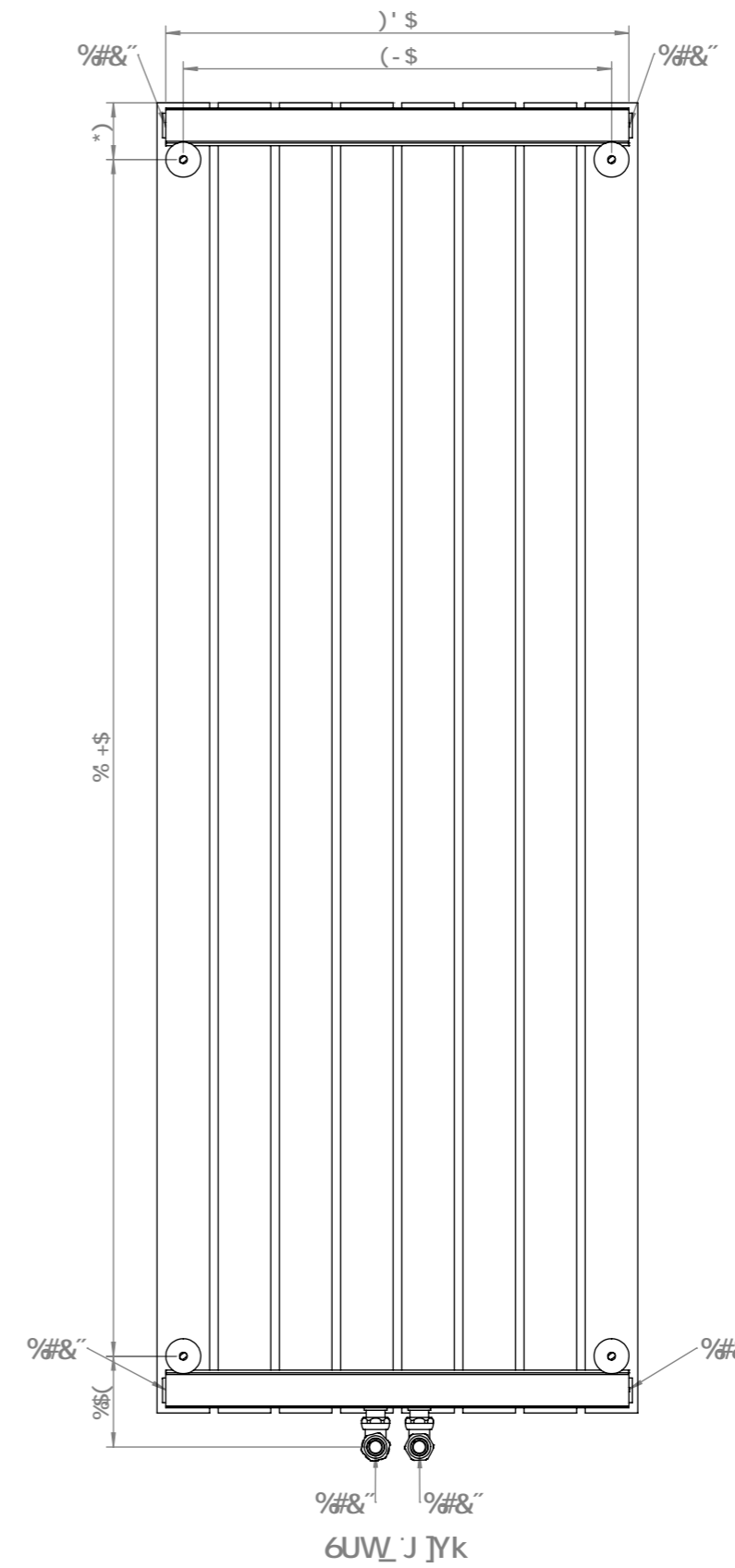
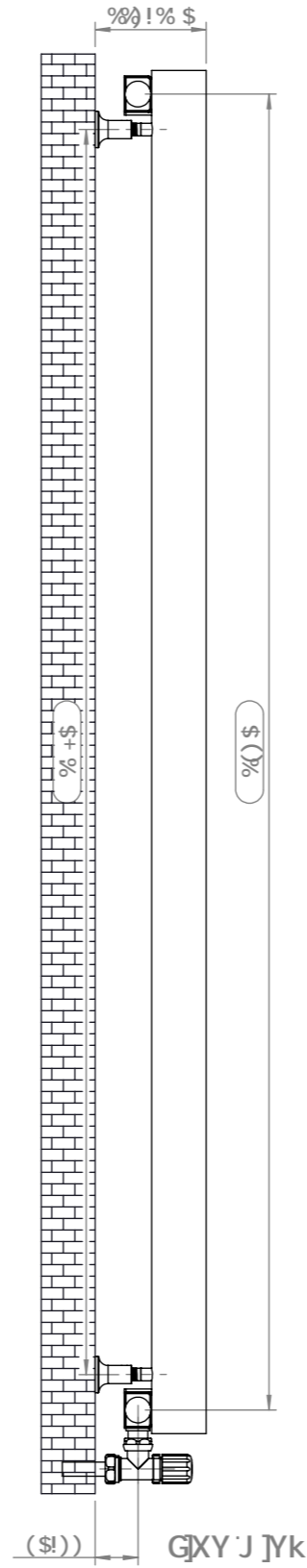
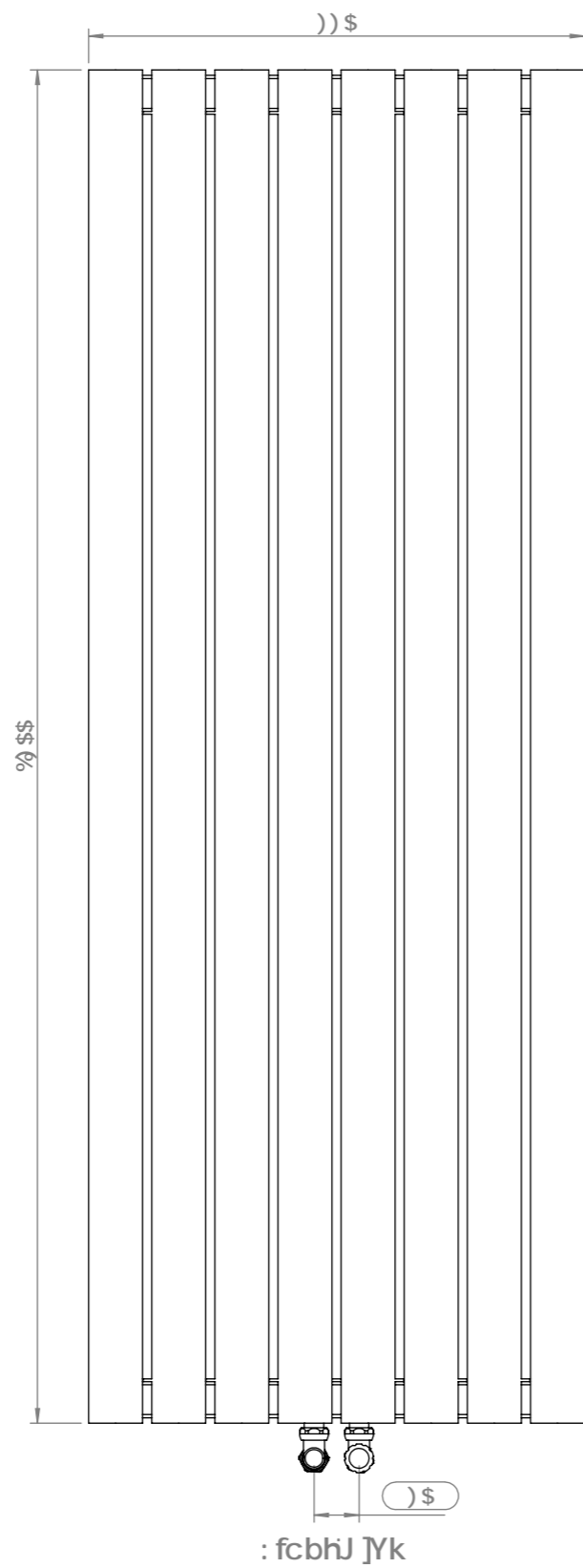

•bgtU`Uhjcb'5WVYgcflYg`

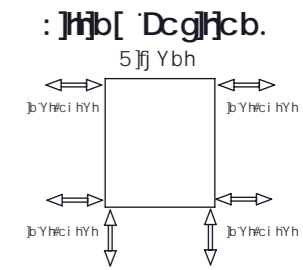
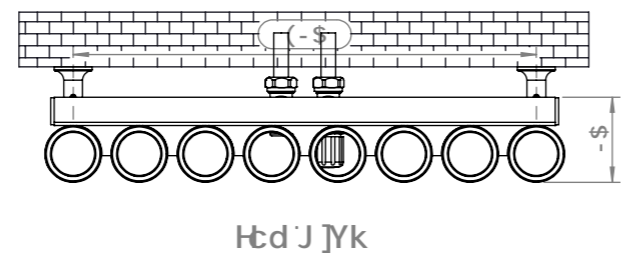
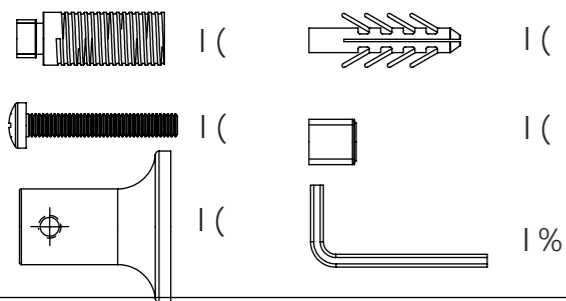

Q|/Öa ^} • a } Åe^/Å Å {
 T æÉY [\ \ ä * AU:•• \ ^ ÅMÆ ÅÖæ
 T æÉY [\ \ ä * A^ \] \ æ \ ^ MÜ \ » Å
 Q \ ^ ÅU q \ ^ ÅMÆ ÅÖUU

MYSTIC-E 184

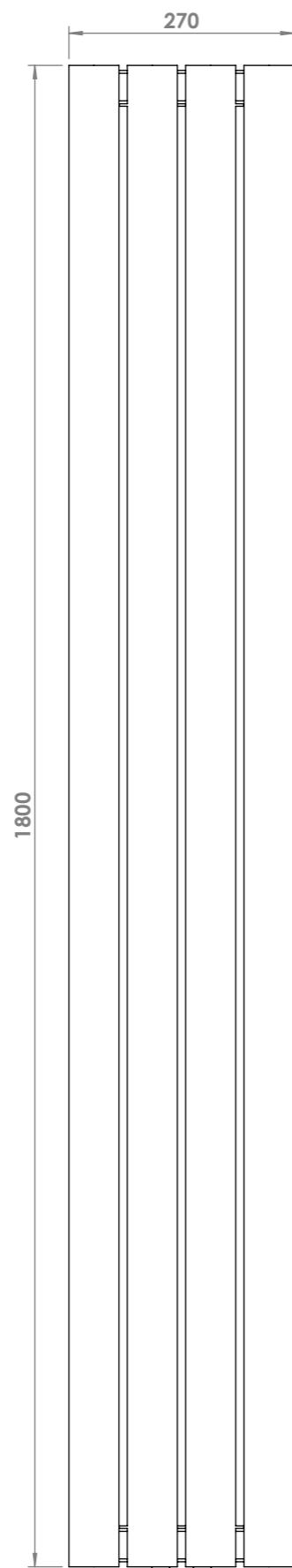

Front View

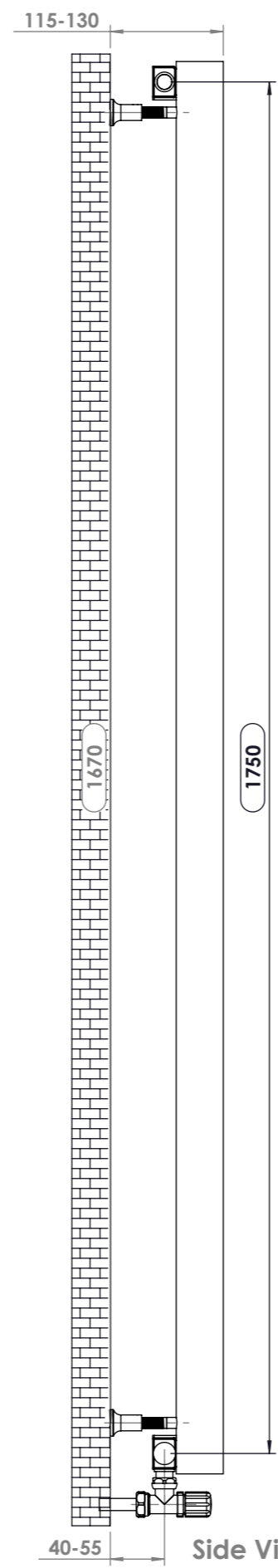

Side View

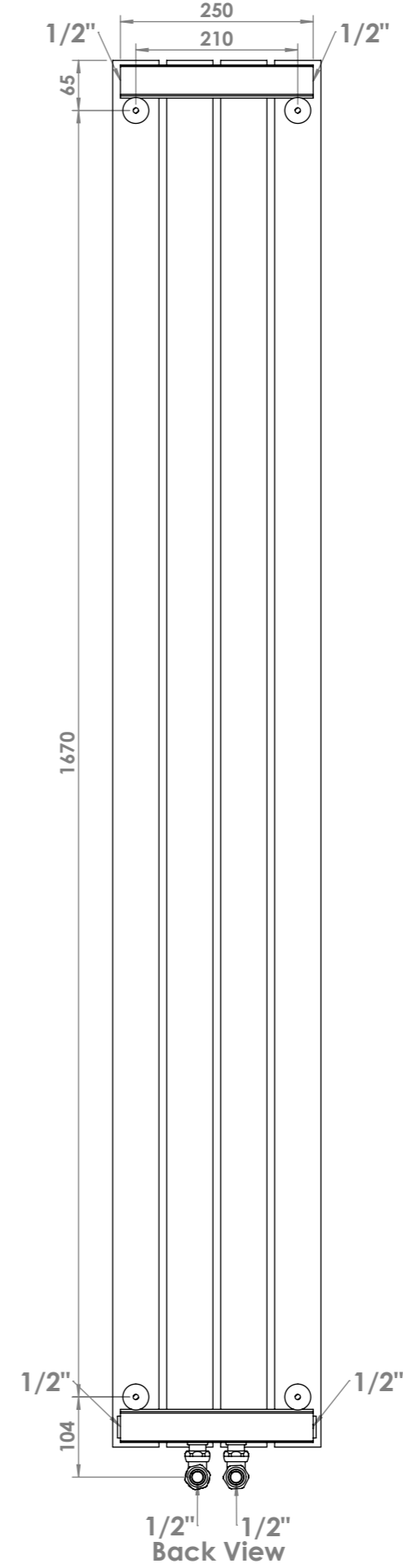



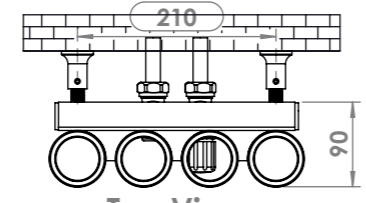

Back View

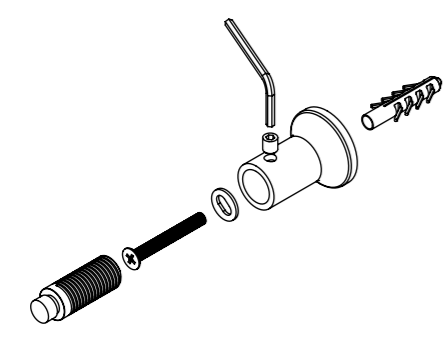
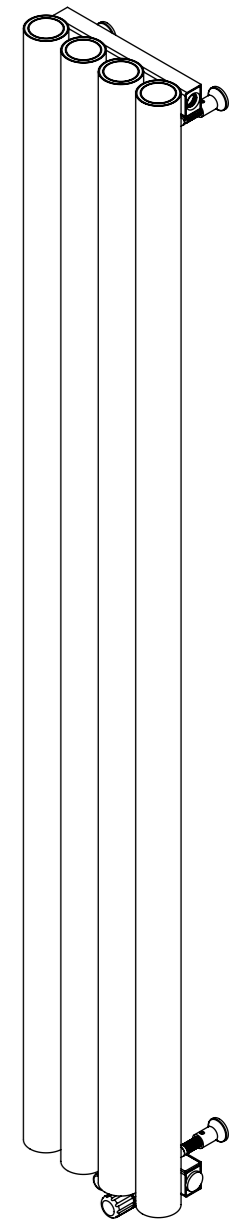

Top View

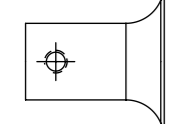
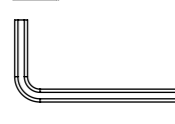

Installation Accesories:

- | | | | |
|---|----|---|----|
|  | x4 |  | x4 |
|  | x4 |  | x4 |
|  | x4 |  | x1 |

Fitting Position:

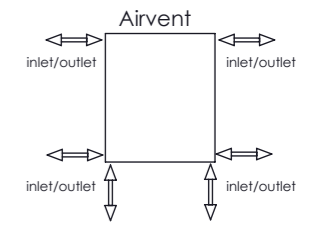



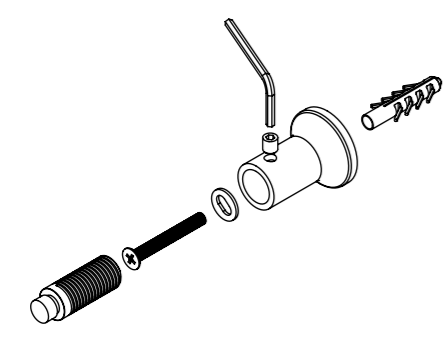
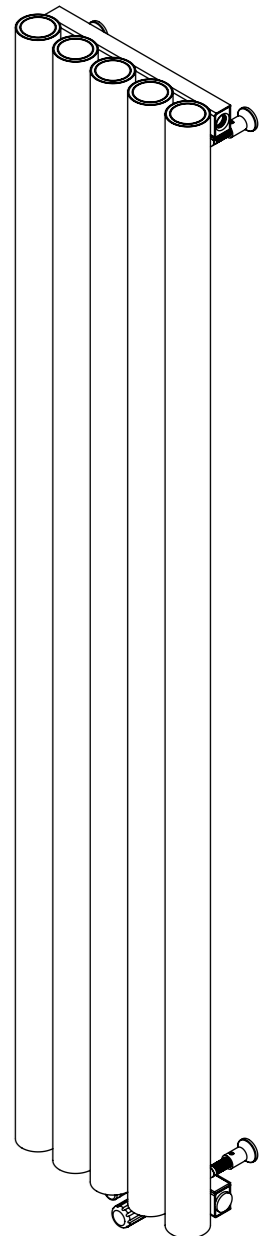
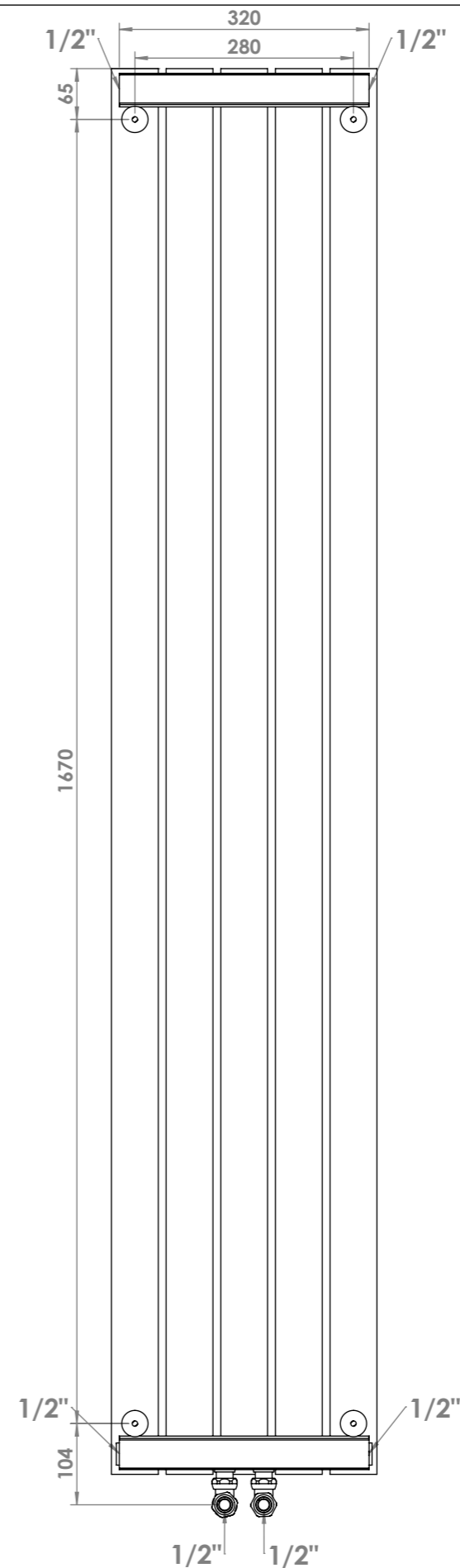
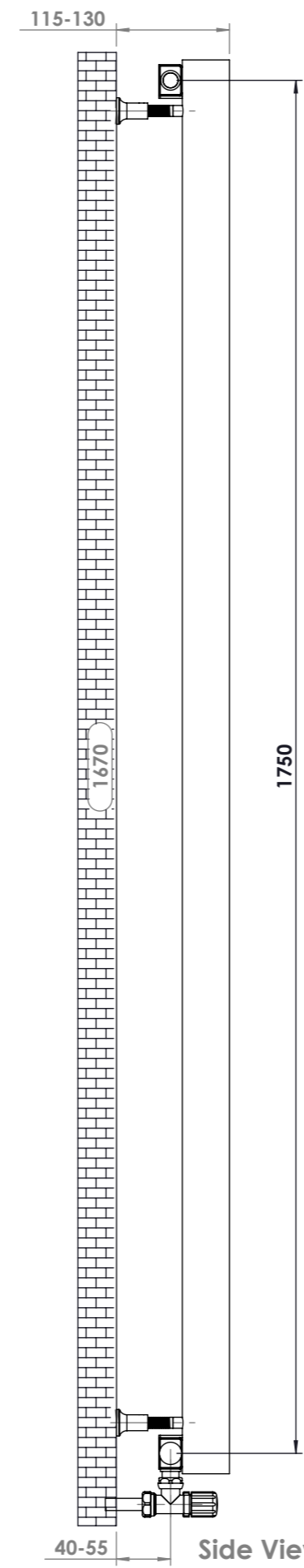
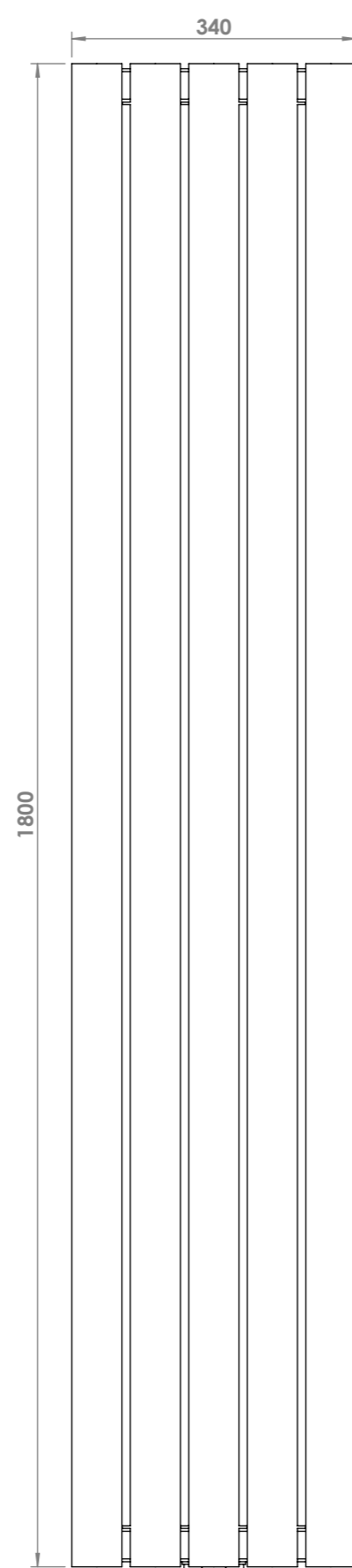

All Dimension are in mm
 Max.Working Pressure = 10 Bar
 Max.Working Temperature=95° C
 Inlet / Outlet : 1/2" BSP

MYSTIC-E 185

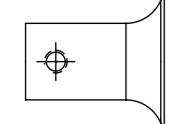
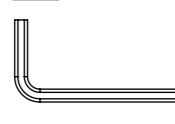

Installation Accesories:

- | | | | |
|---|----|---|----|
|  | x4 |  | x4 |
|  | x4 |  | x4 |
|  | x4 |  | x1 |

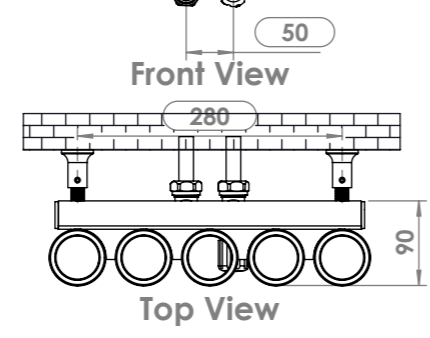

Fitting Position:

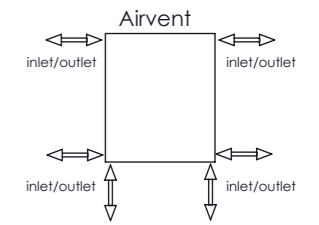

All Dimension are in mm
 Max.Working Pressure = 10 Bar
 Max.Working Temperature=95° C
 Inlet / Outlet : 1/2" BSP

A MGH=7!9.&\$(\$)

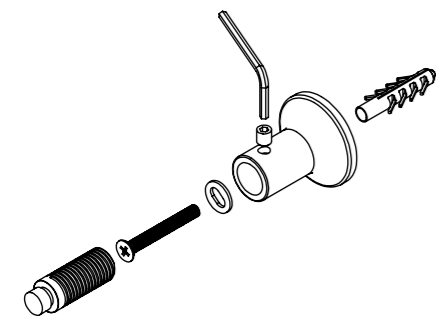

⊕gU~Uhc b'5WVYgc f]Yg'

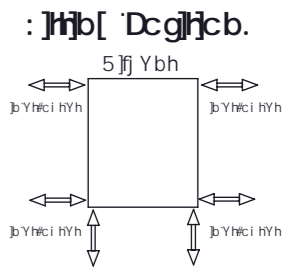
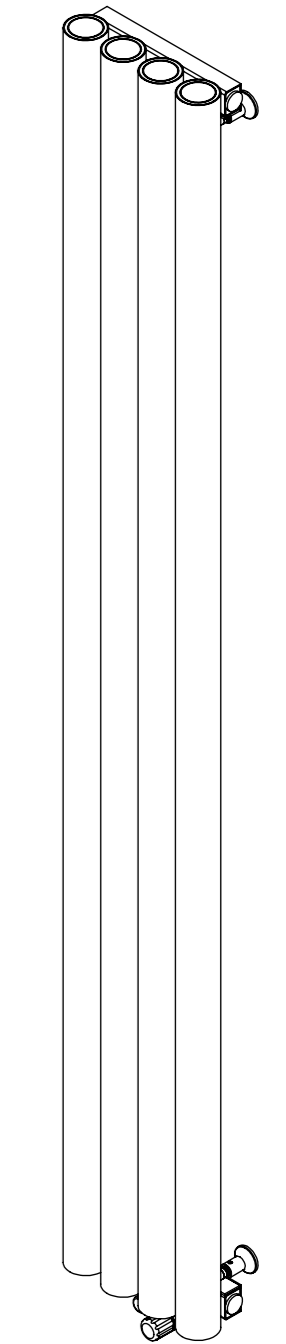
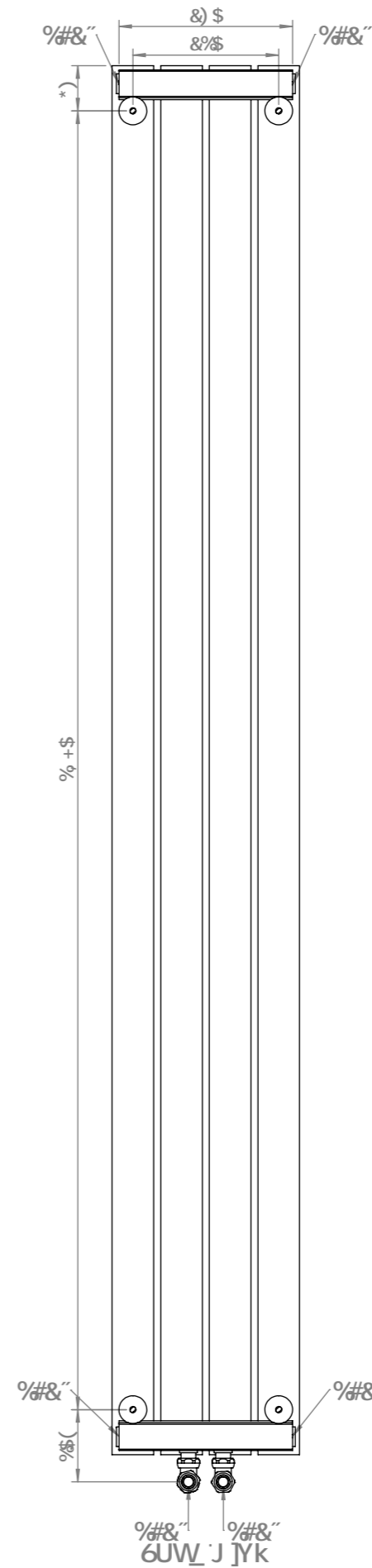
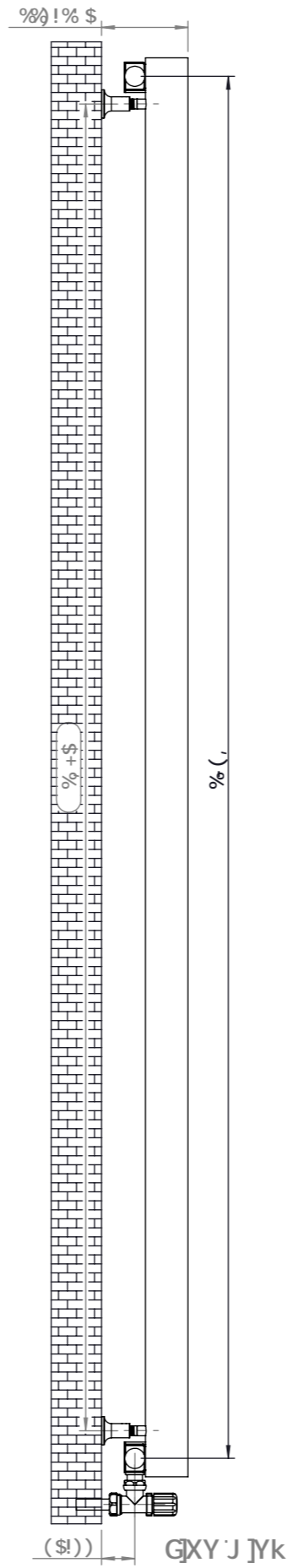
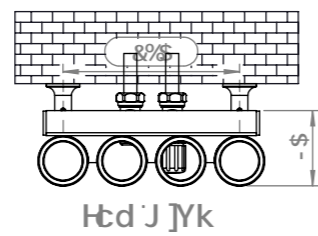
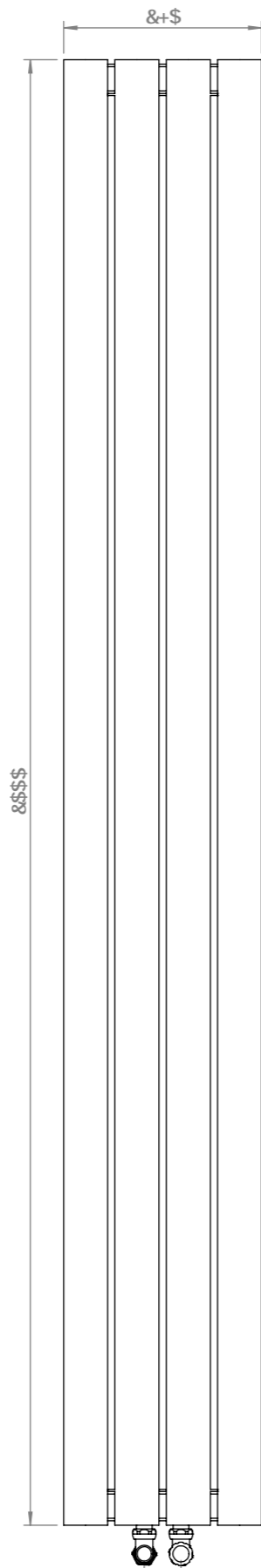
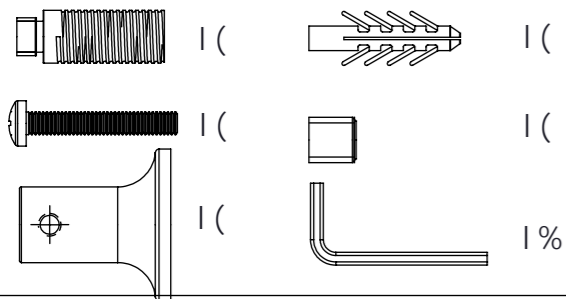

Qh/Oa ^}•a } Ae^/A {
 T æEY [\!ā *AU!•• ^AMF€AOæ
 T æEY [\!ā *A^ {]!æ]^MU! »AO
 Q!^AU q^AMF€AOUU

MYSTIC-E 205

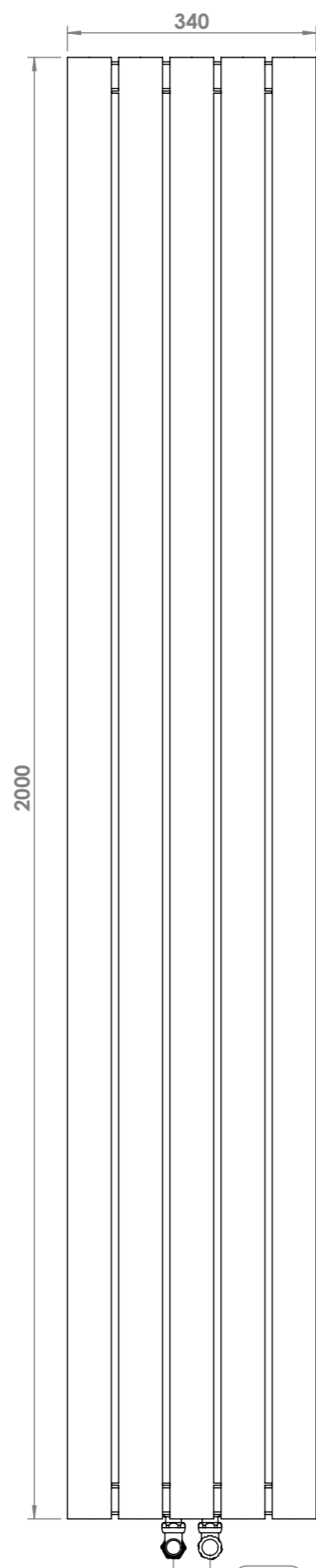

Front View

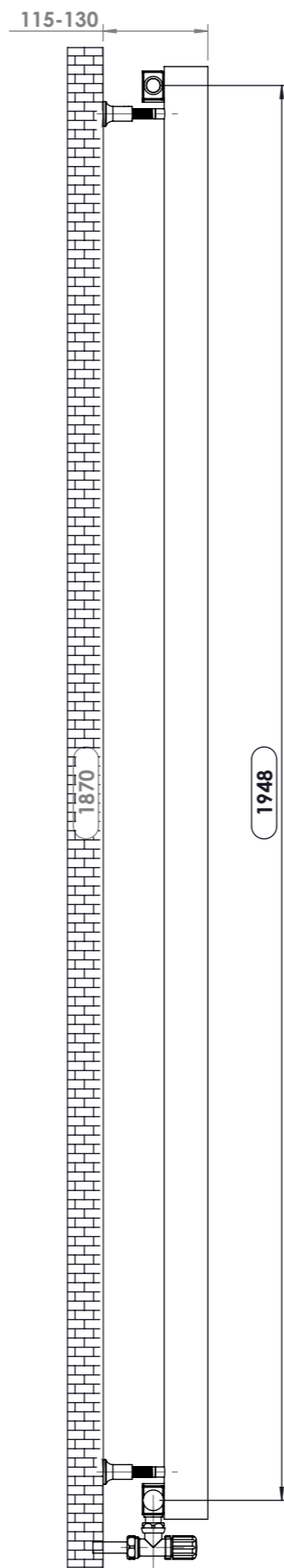



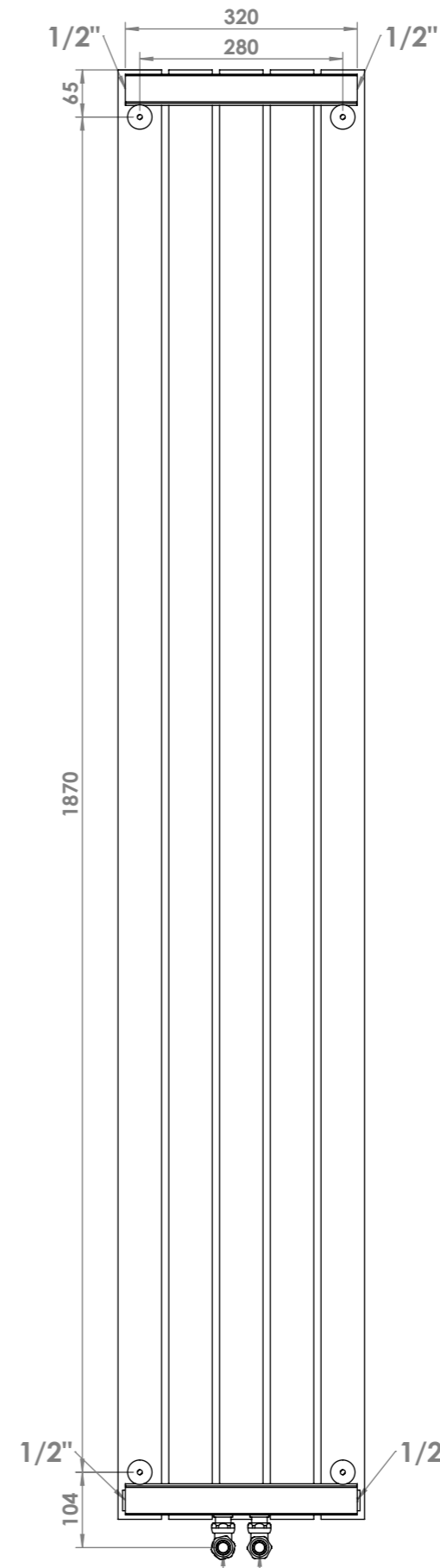

Side View

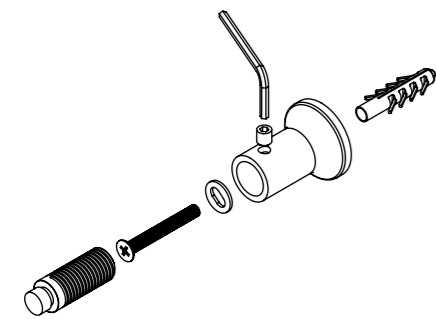
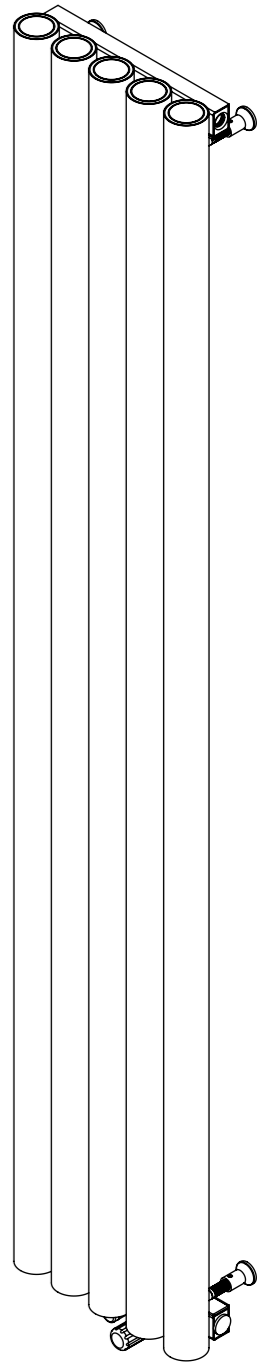

Back View

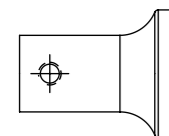
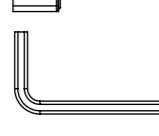

Installation Accesories:

- | | | | |
|---|----|---|----|
|  | x4 |  | x4 |
|  | x4 |  | x4 |
|  | x4 |  | x1 |

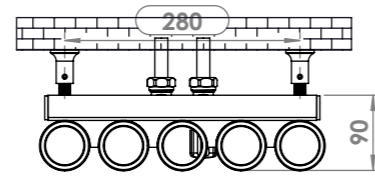

Top View

Fitting Position:

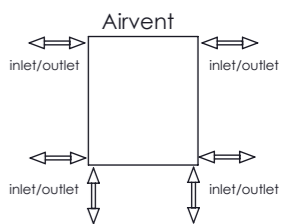

All Dimension are in mm
 Max.Working Pressure = 10 Bar
 Max.Working Temperature=95° C
 Inlet / Outlet : 1/2" BSP

MYSTIC-E 206

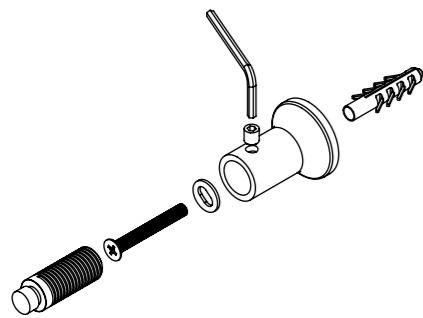
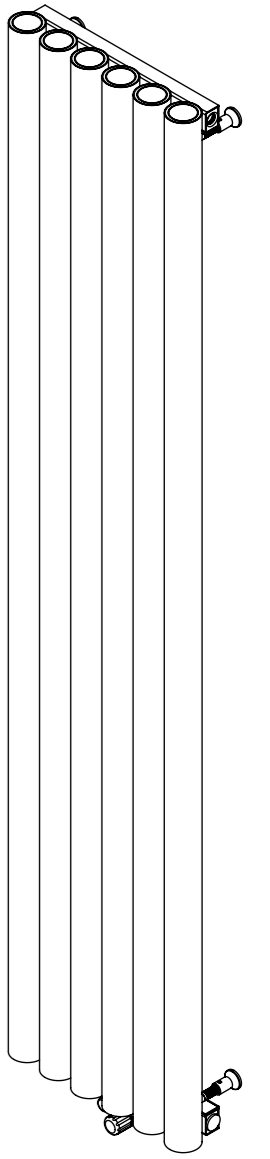
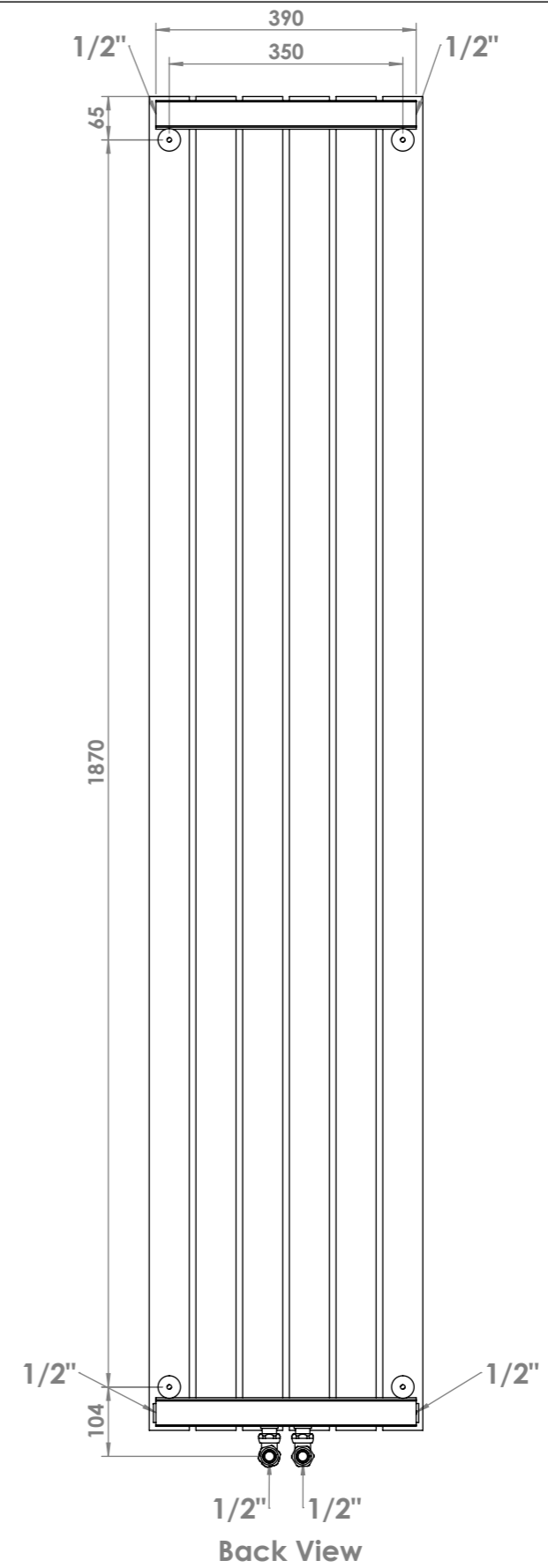
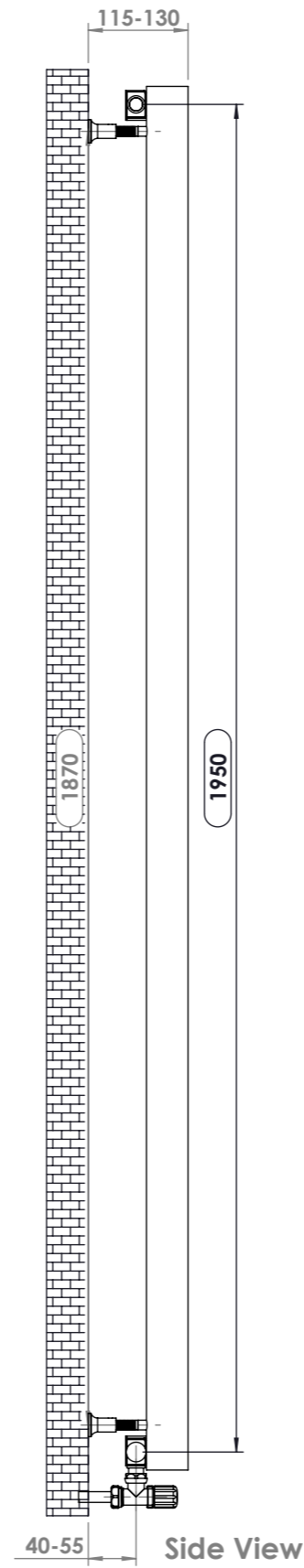
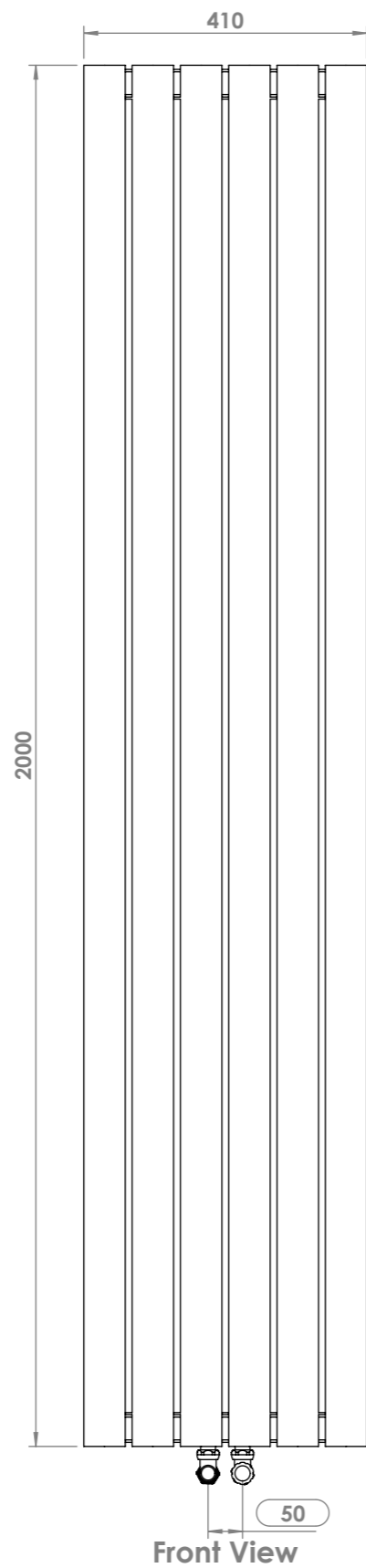

Installation Accesories:

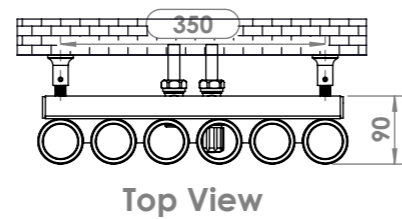
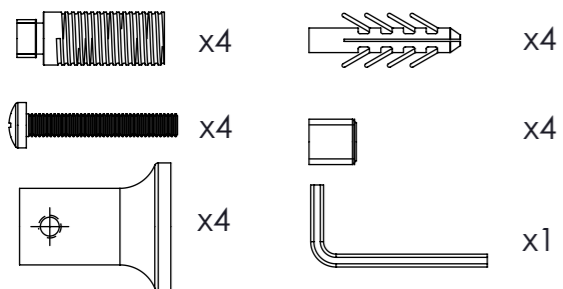

Fitting Position:

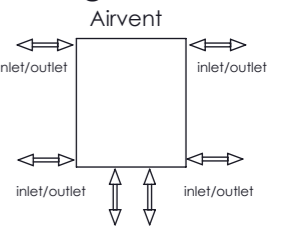

All Dimension are in mm
 Max.Working Pressure = 10 Bar
 Max.Working Temperature=95° C
 Inlet / Outlet : 1/2" BSP

A MGH=7!9 &\$+

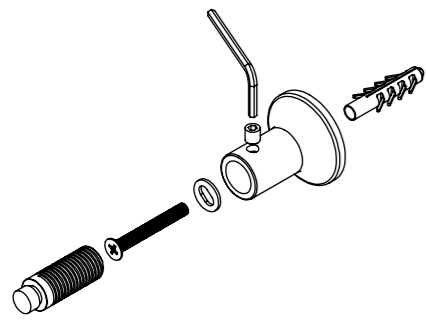
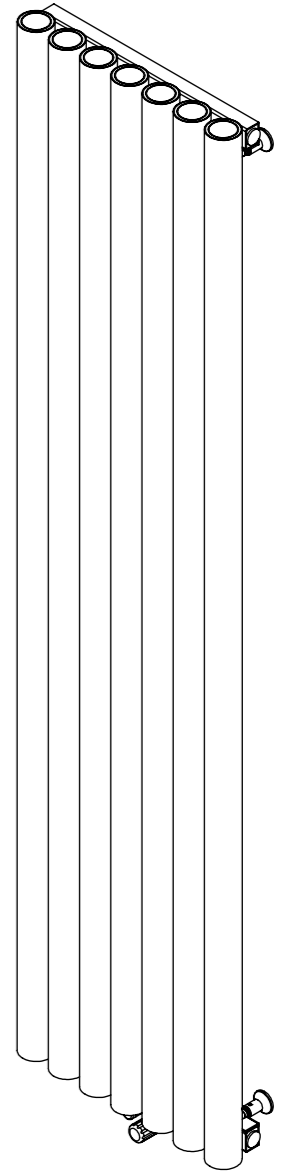
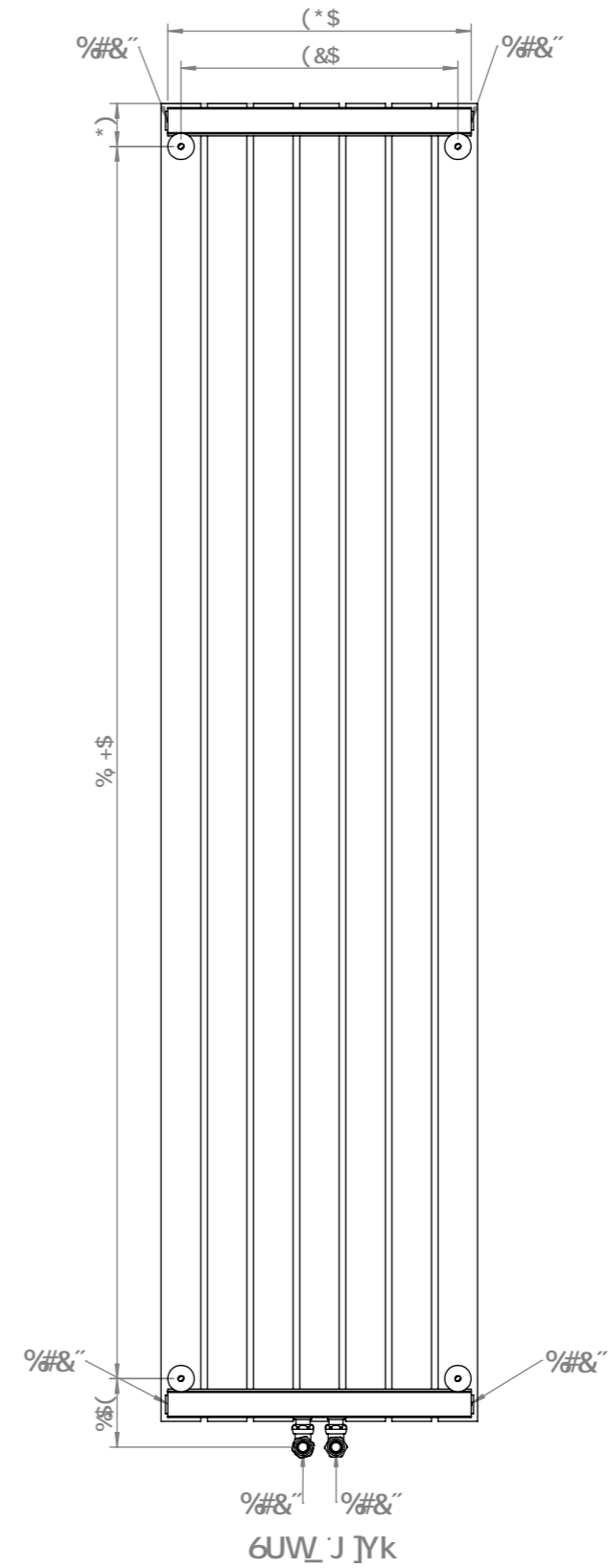
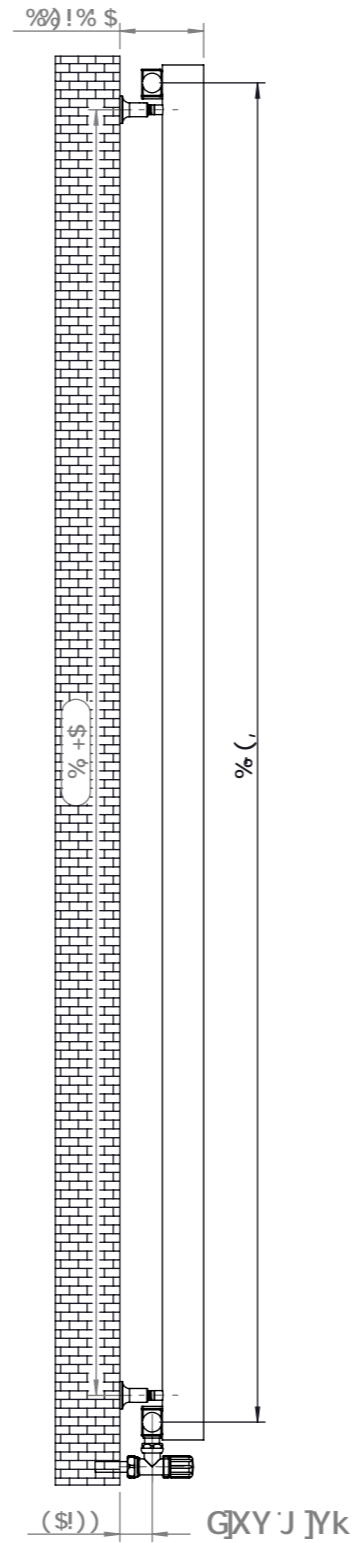
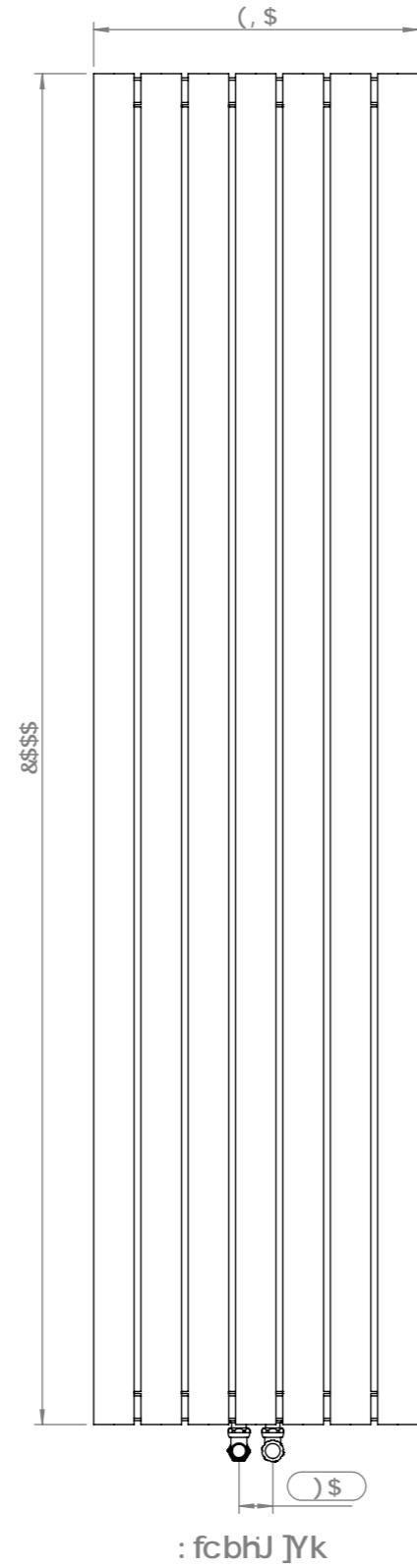

~bgtU~Uhjcb'5WVYgcflYg'

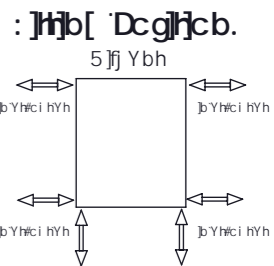
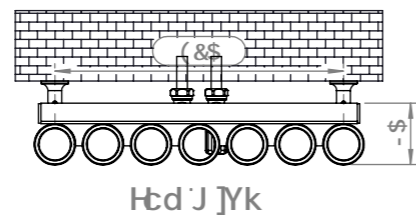
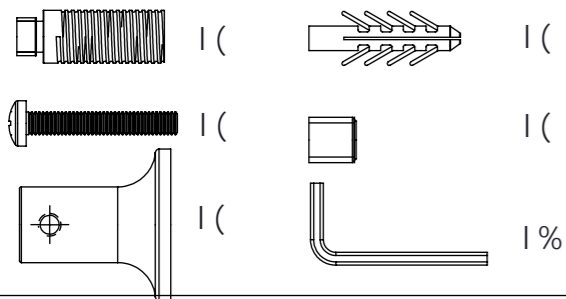

Qh/Oa ^} • a } Ae^/A {

T æEY [\! a * AU:•• \^AMF€AOæ

T æEY [\! a * A^ \] !æ \^MUJ »AO

Q \^AU q^AMF€AOUU

A MGH=7!9'&\$,

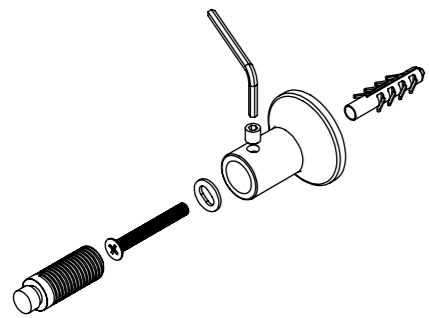
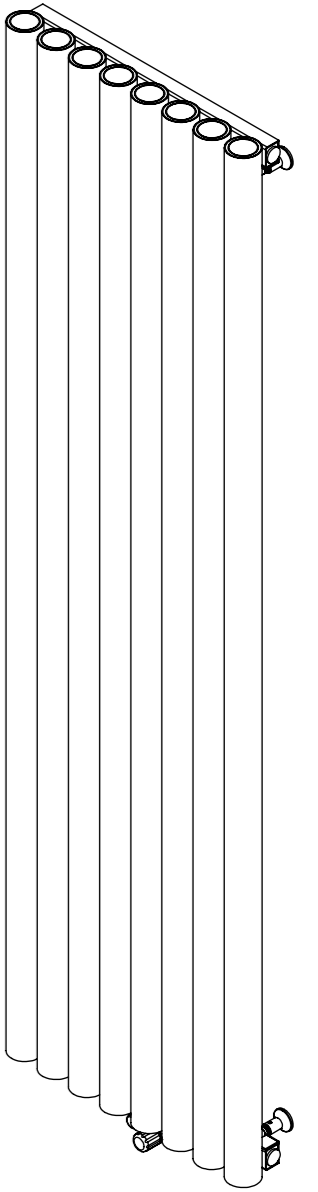
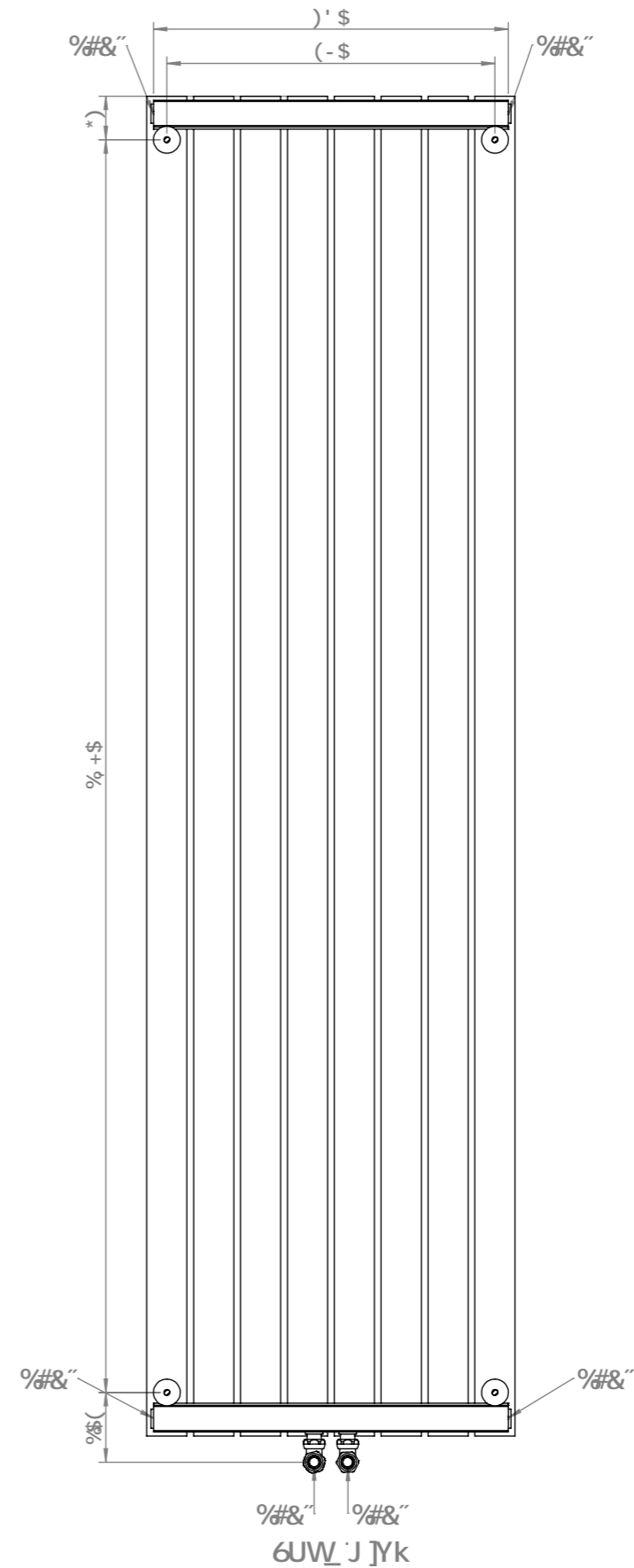
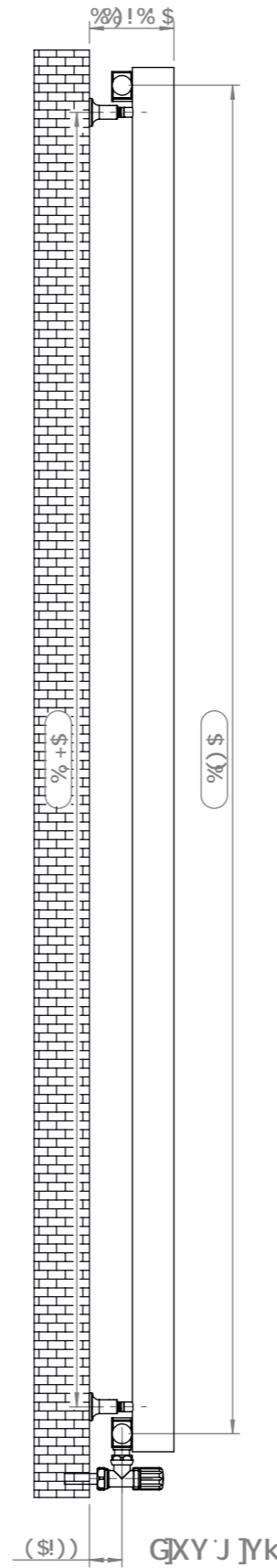
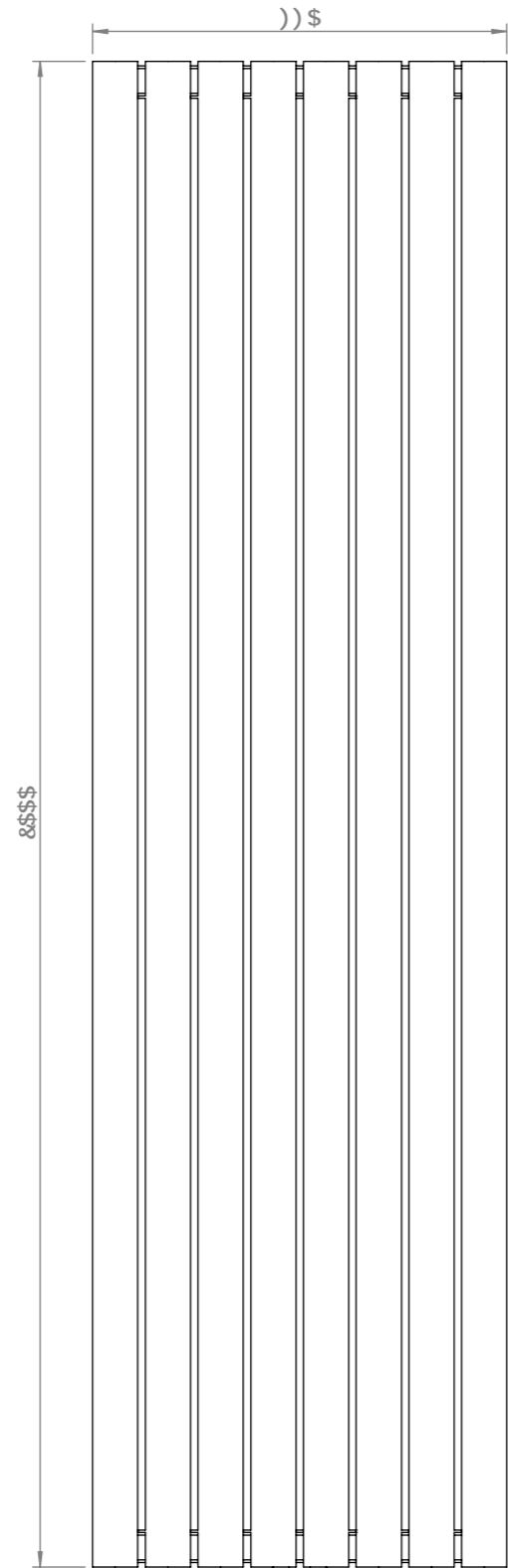

~bgtU~Uhjcb'5WVYgc fJYg'

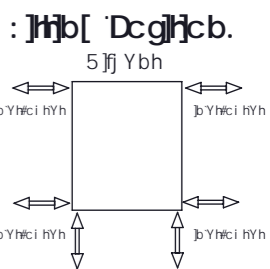
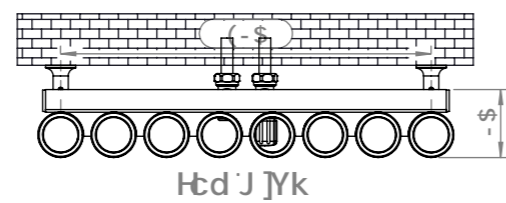
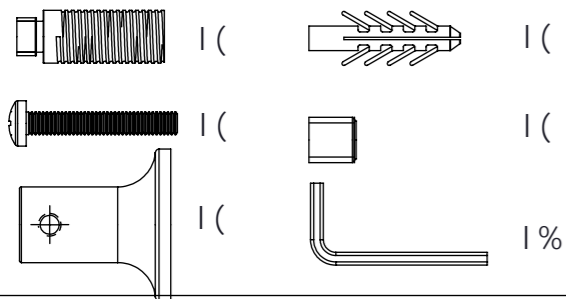

Qh/Oa ^} • a } Ae^/A {
T æÉY [\ à * AU:•• \ ^ AMEAOæ
T æÉY [\ à * A^ {] |æ | ^MUJ »O
Q | ^ AU q ^ AMEAOUU

AMGH719'(\$)

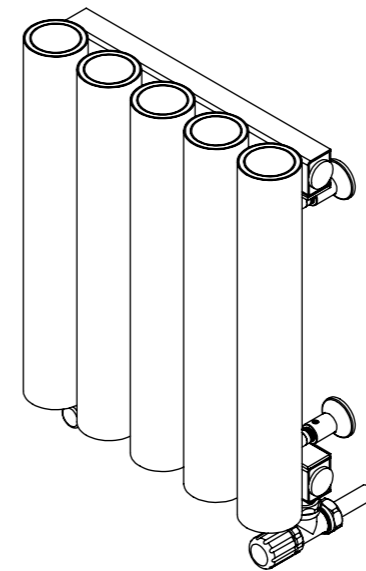
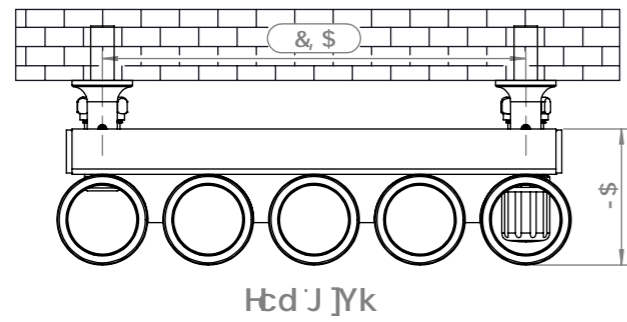
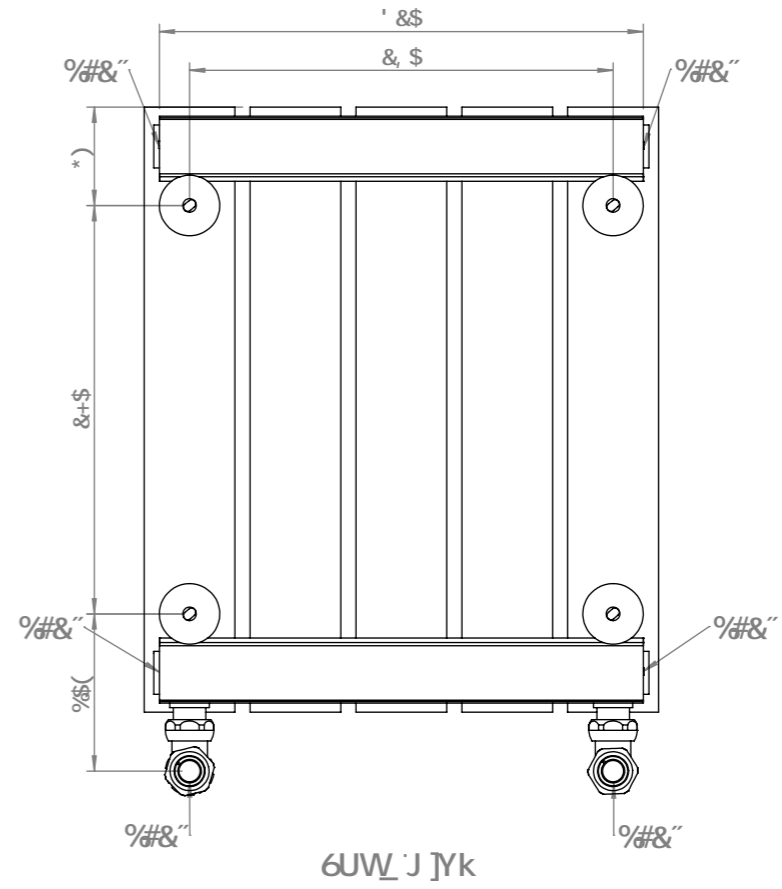
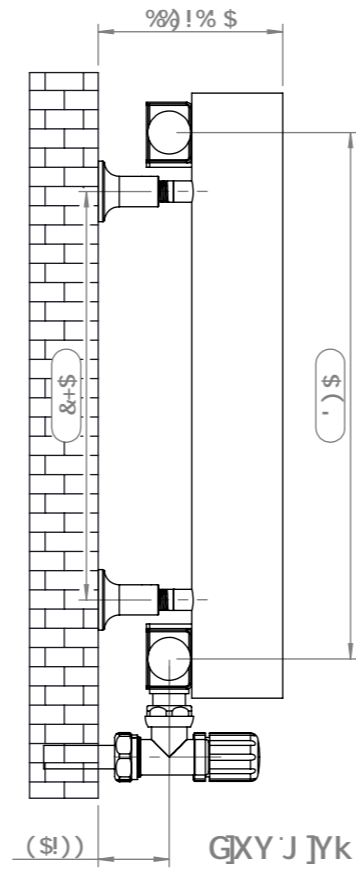
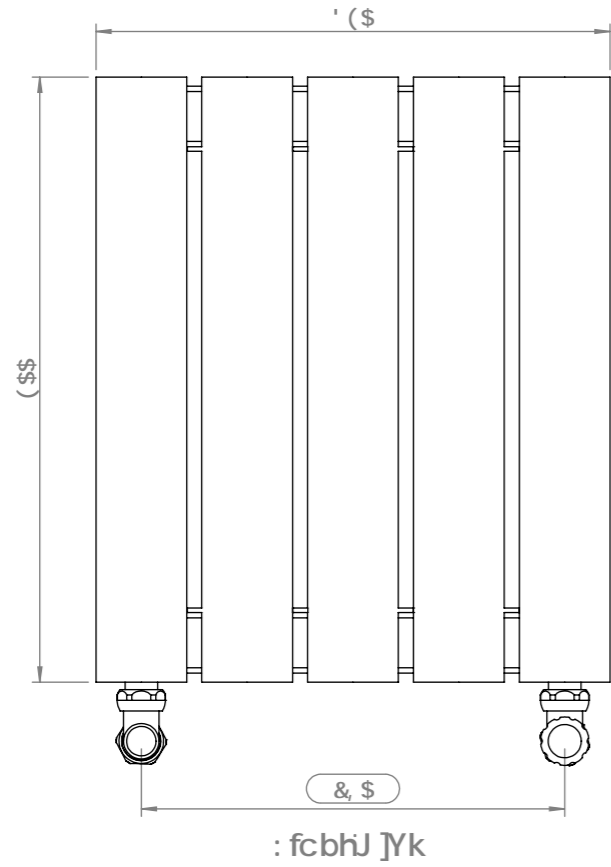

⊕gU`Uhcb'5WVYgc fJYg'

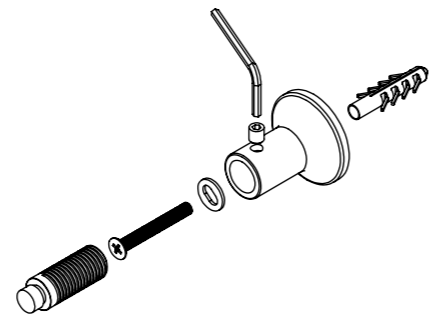
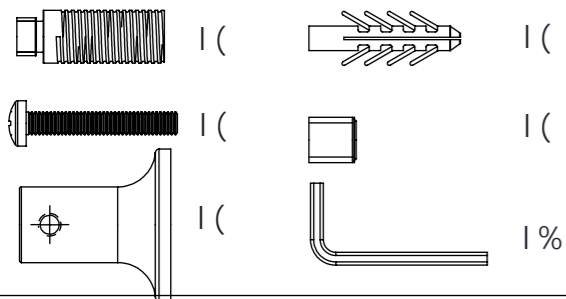

:]h['Dcgh]cb.

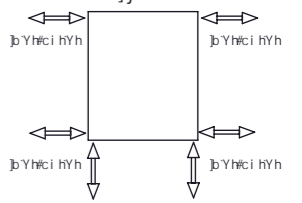

Qh/Aa ^}•a } Ae^/A {
 T æEY [\ā *AU:•• \^AMF€AOæ
 T æEY [\ā *A^ \] |æ |^MUJ >O
 Q| ^AU q^ AMF€AOUU

A MGH=7!9'(\$*

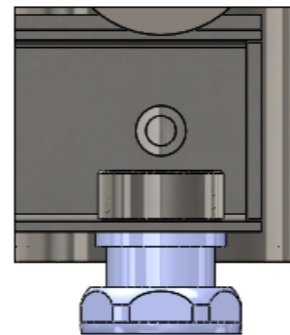
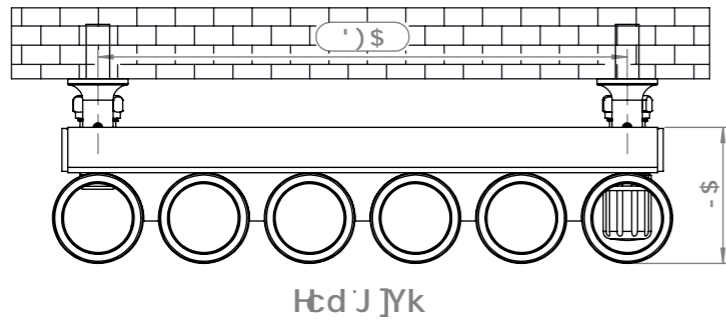
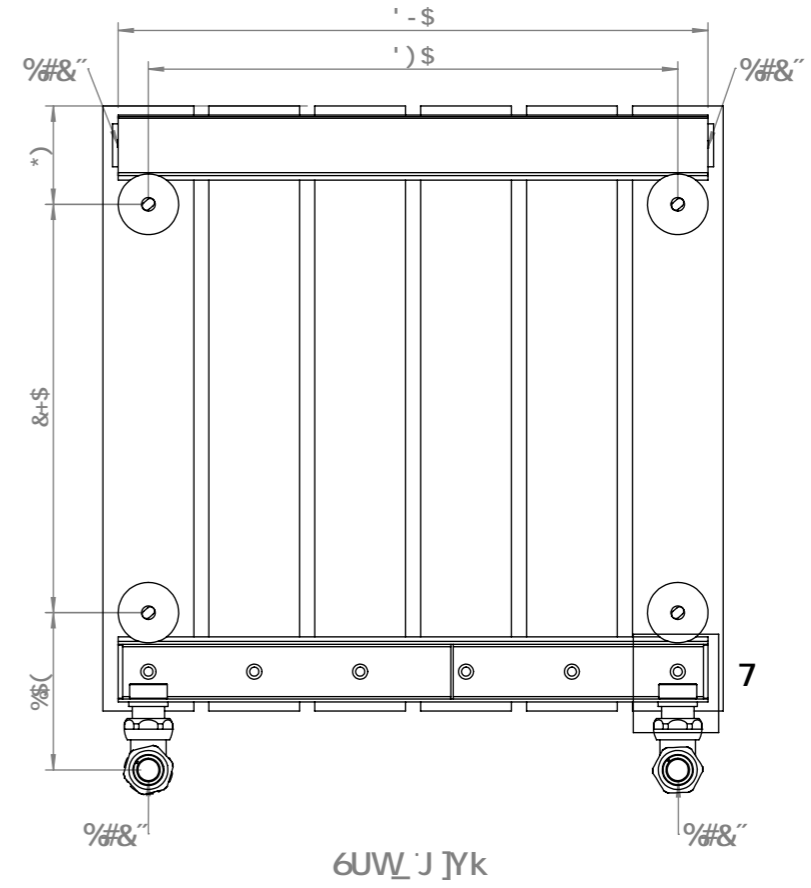
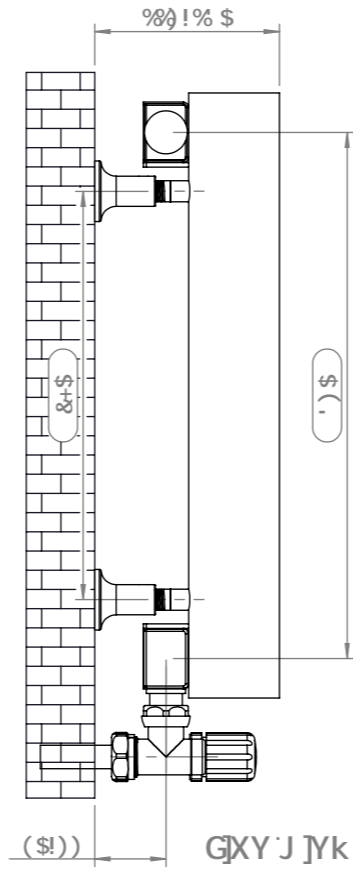
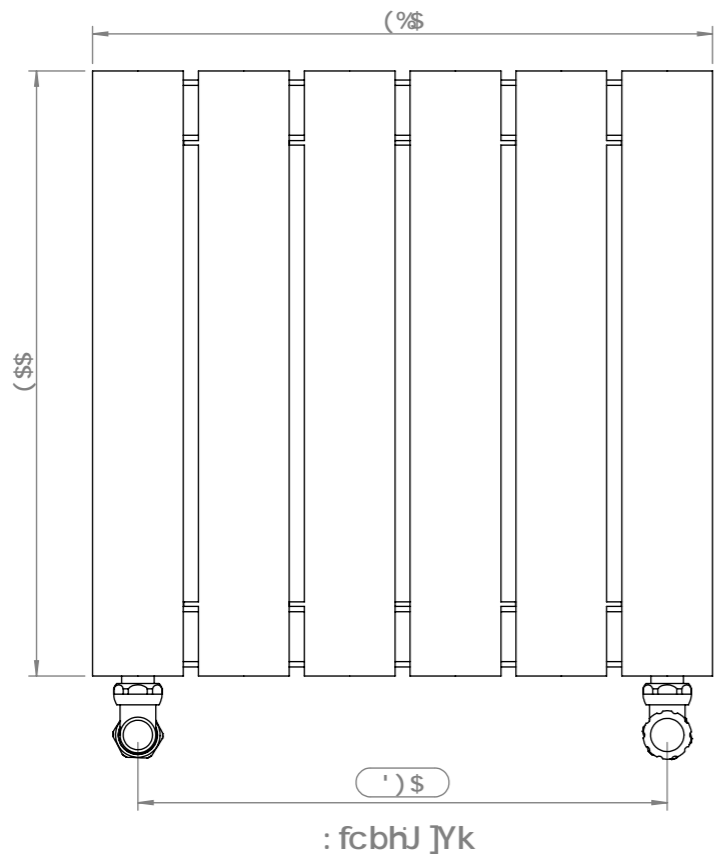

895-@7' G7 5@9&.'"

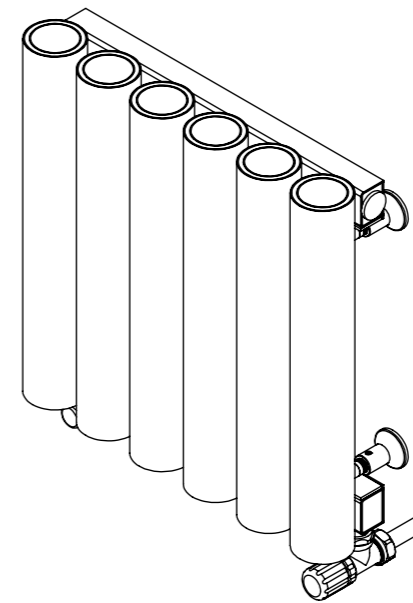

±bgU`Uhcb'5WVYgc fJYg'

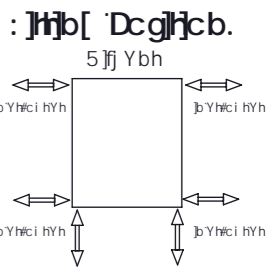
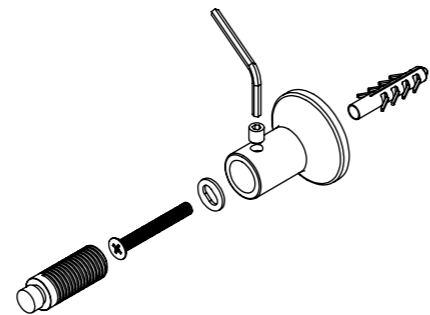
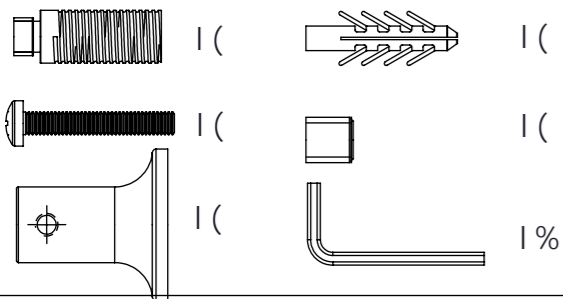

Qh/Aa ^} a } Ae^/A {
T æÉY [\ a * AU: ^•• \ ^ AMEAOæ
T æÉY [\ a * A^ \] \ æ \ ^MU \ »O
Q \ ^AU q^ ^MEAYOUU

MYSTIC-E 407

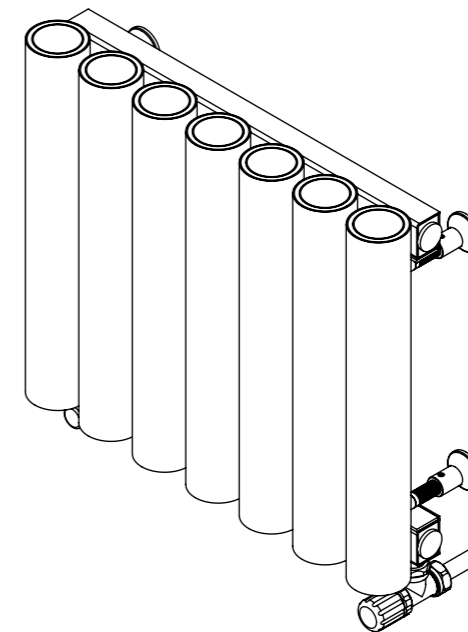
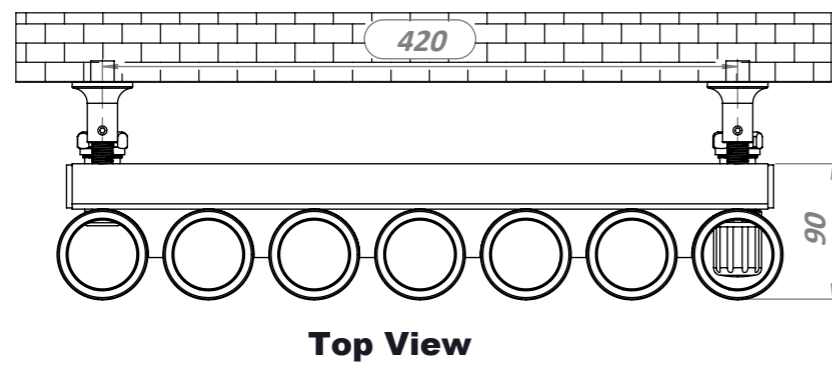
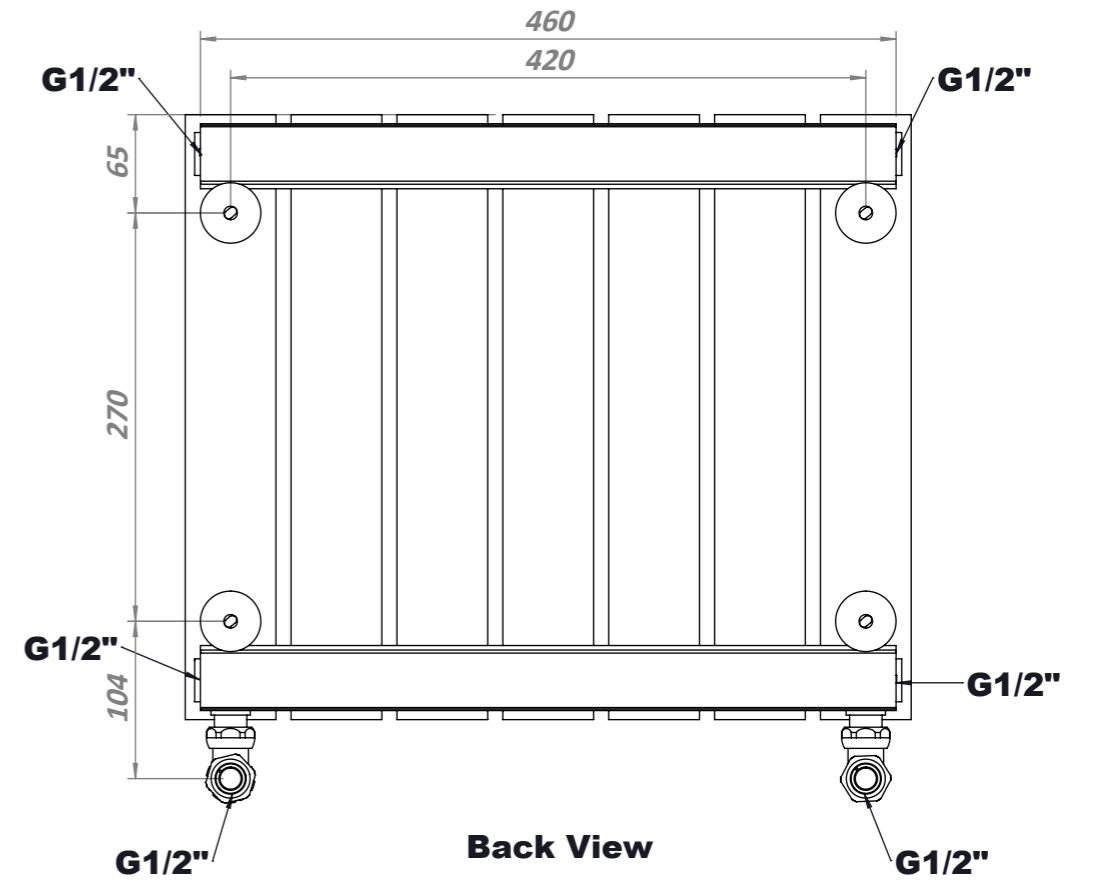
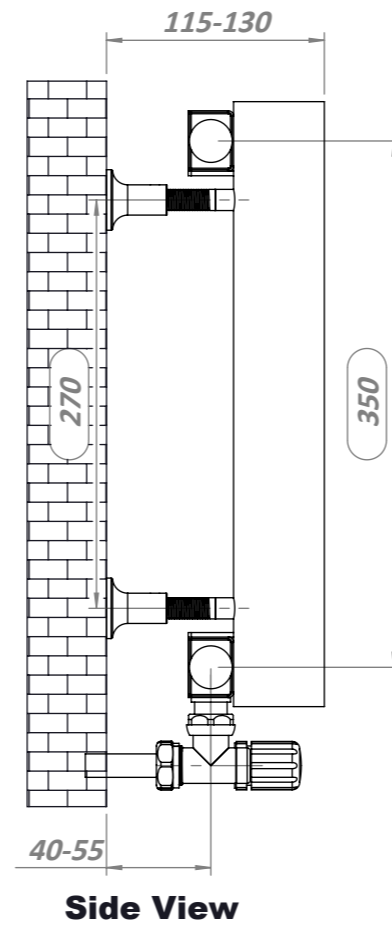
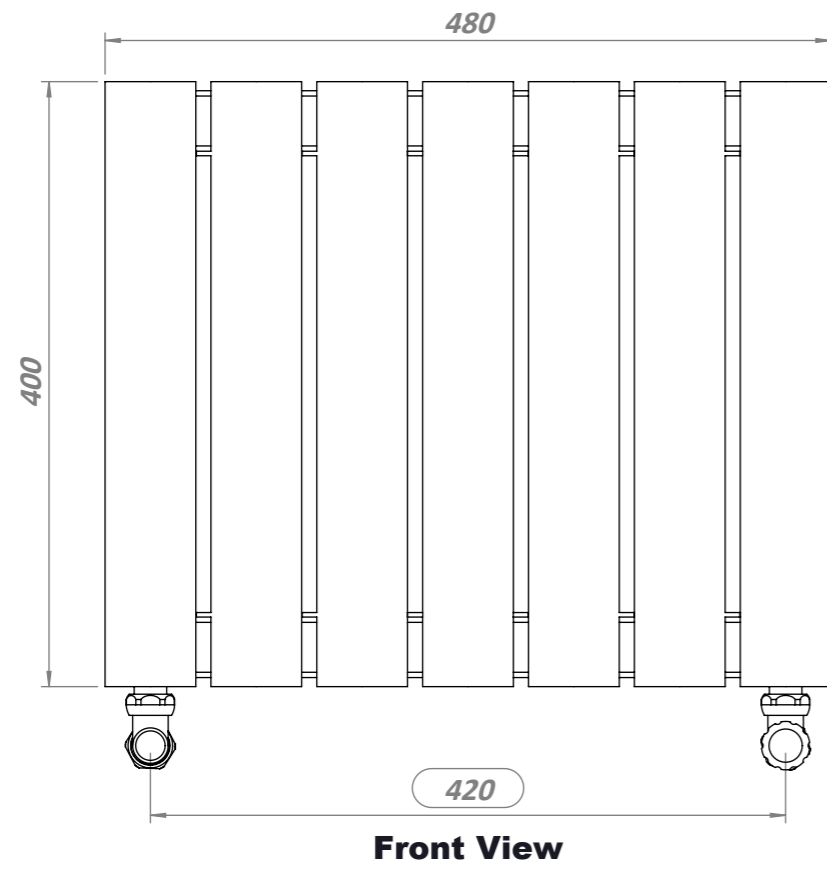

Installation Accesories:

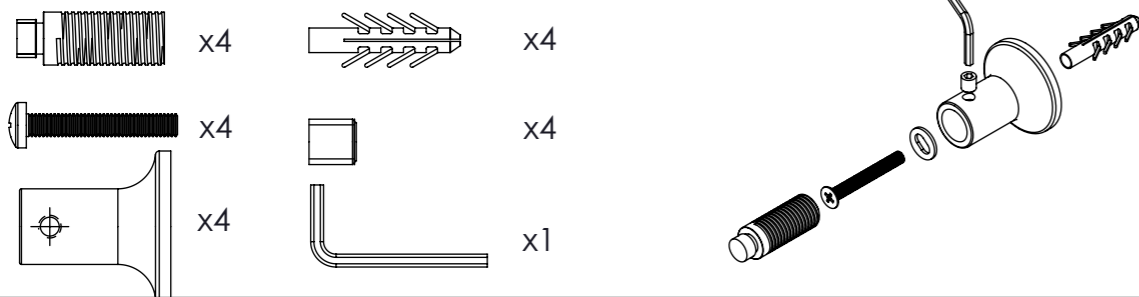

Fitting Position:

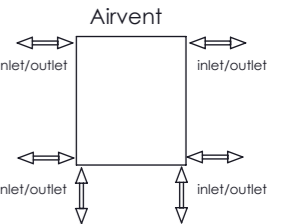

All Dimension are in mm
 Max.Working Pressure = 10 Bar
 Max.Working Temperature=95° C
 Inlet / Outlet : 1/2" BSP

A MGH-7!9' (\$,

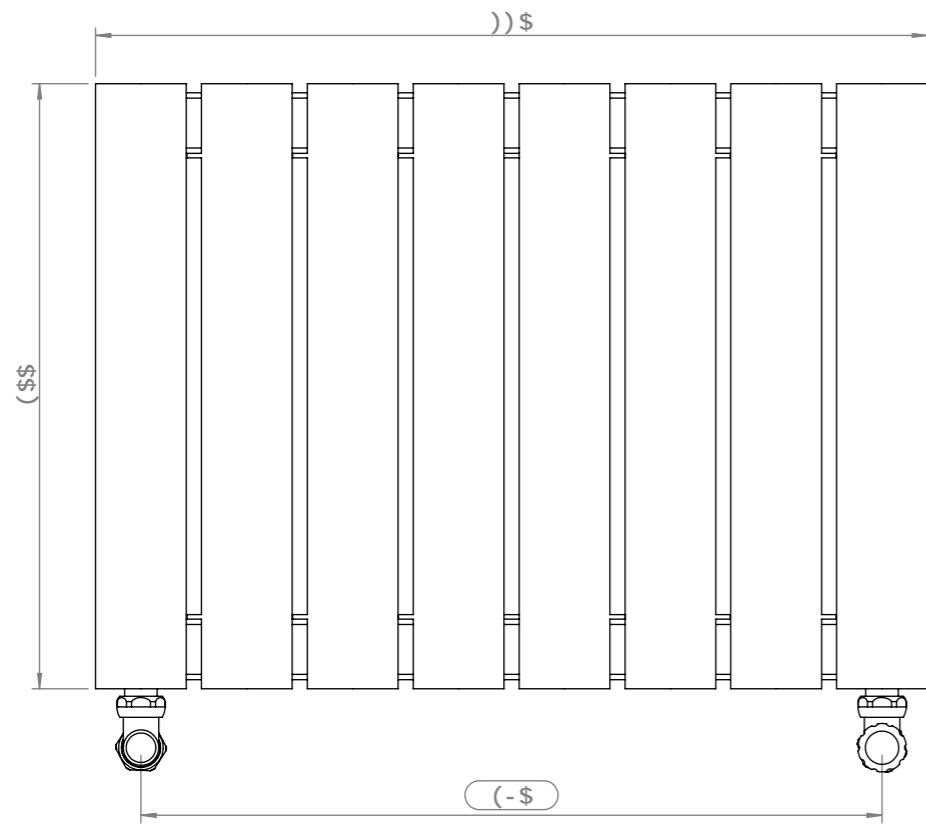

: fcbhJ JYk

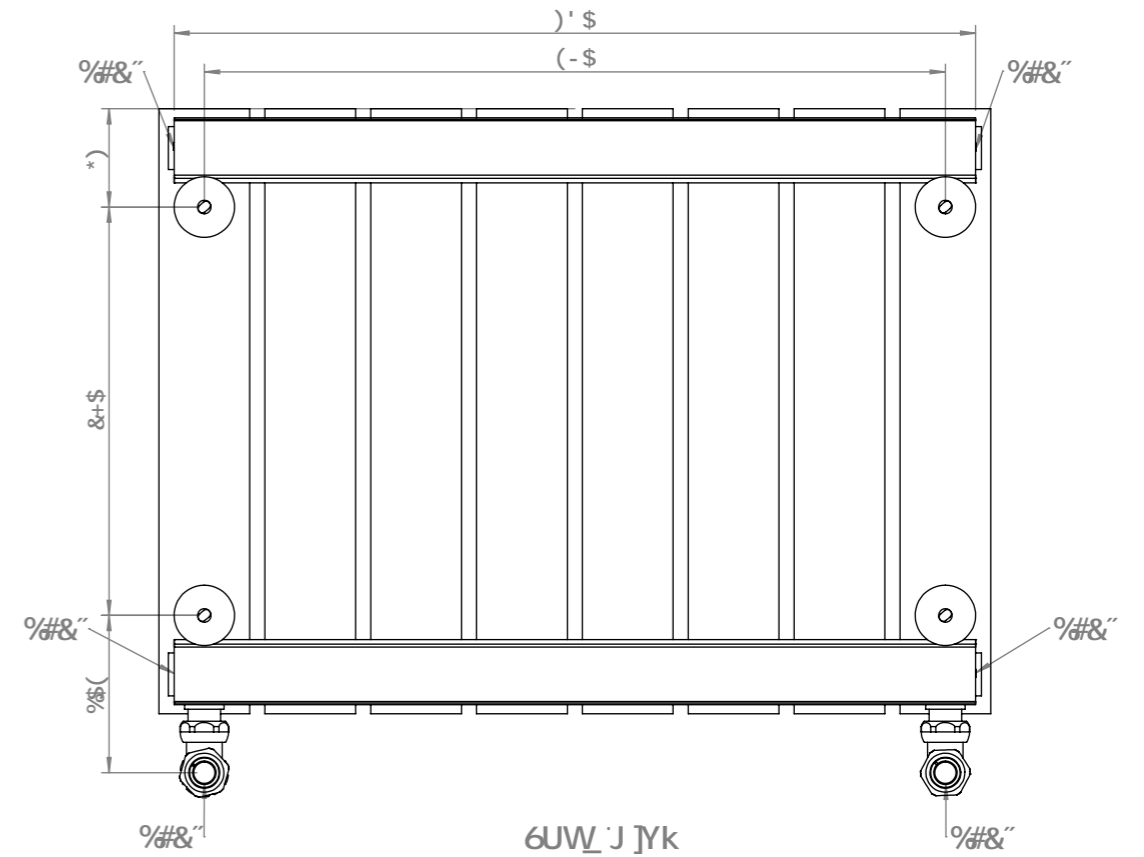
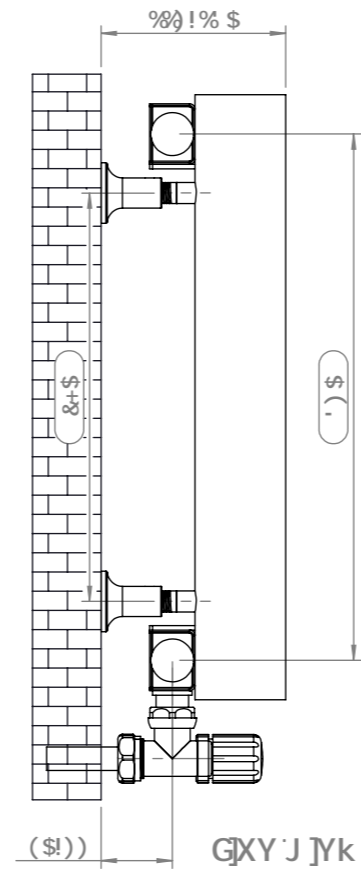

6UW' JYk

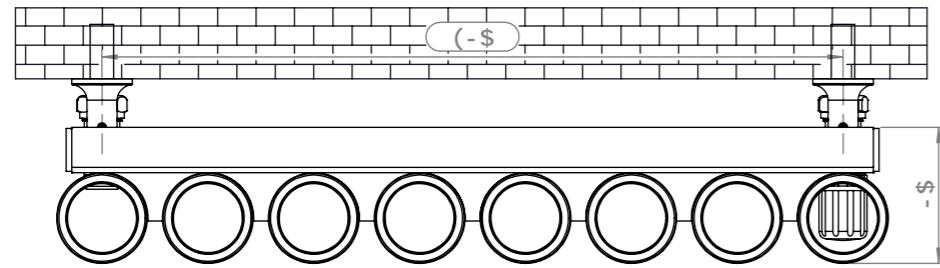

Htd' JYk

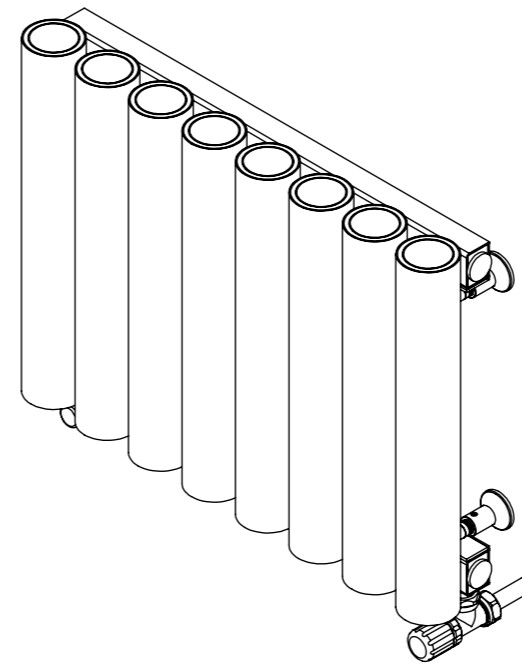

⊕bgU~Ujcb'5WVYgcflYg'

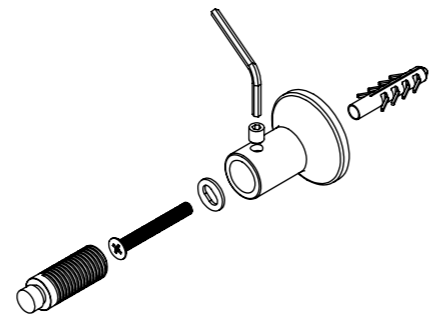
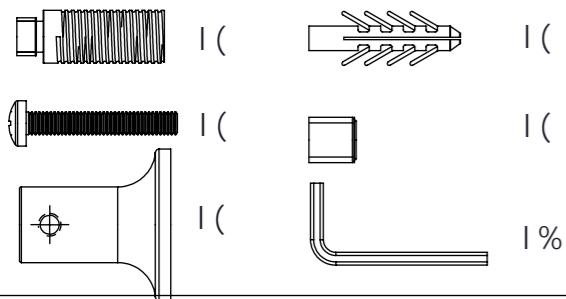

:]h['Dcgh]cb.

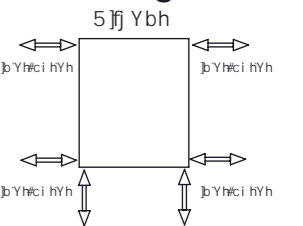

Qh/Aa ^}•a } Ae^/a A {
T æÉY [\ā *AU!•• ^AMFEOæ
T æÉY [\ā *A^ \] !æ]^MUI »O
Q| ^AU q^ AMFEOUU

A MGH=7!9'(\$-

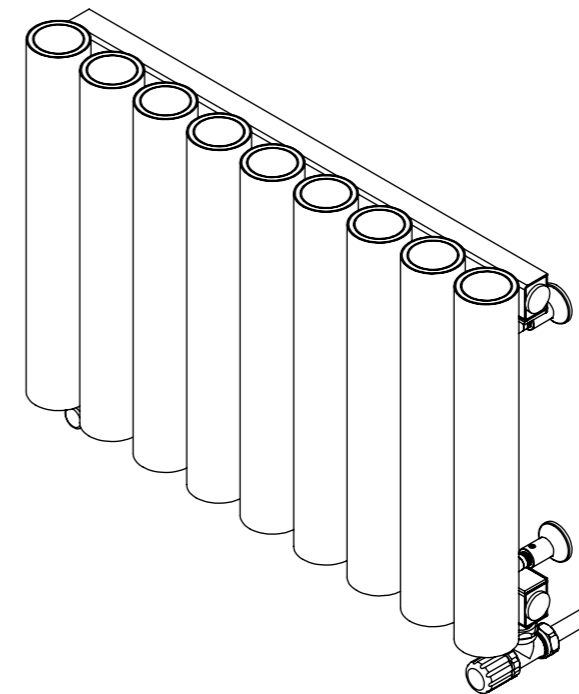
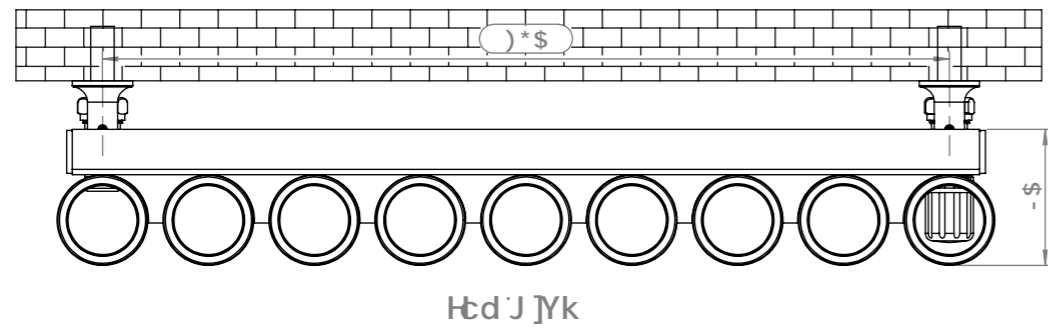
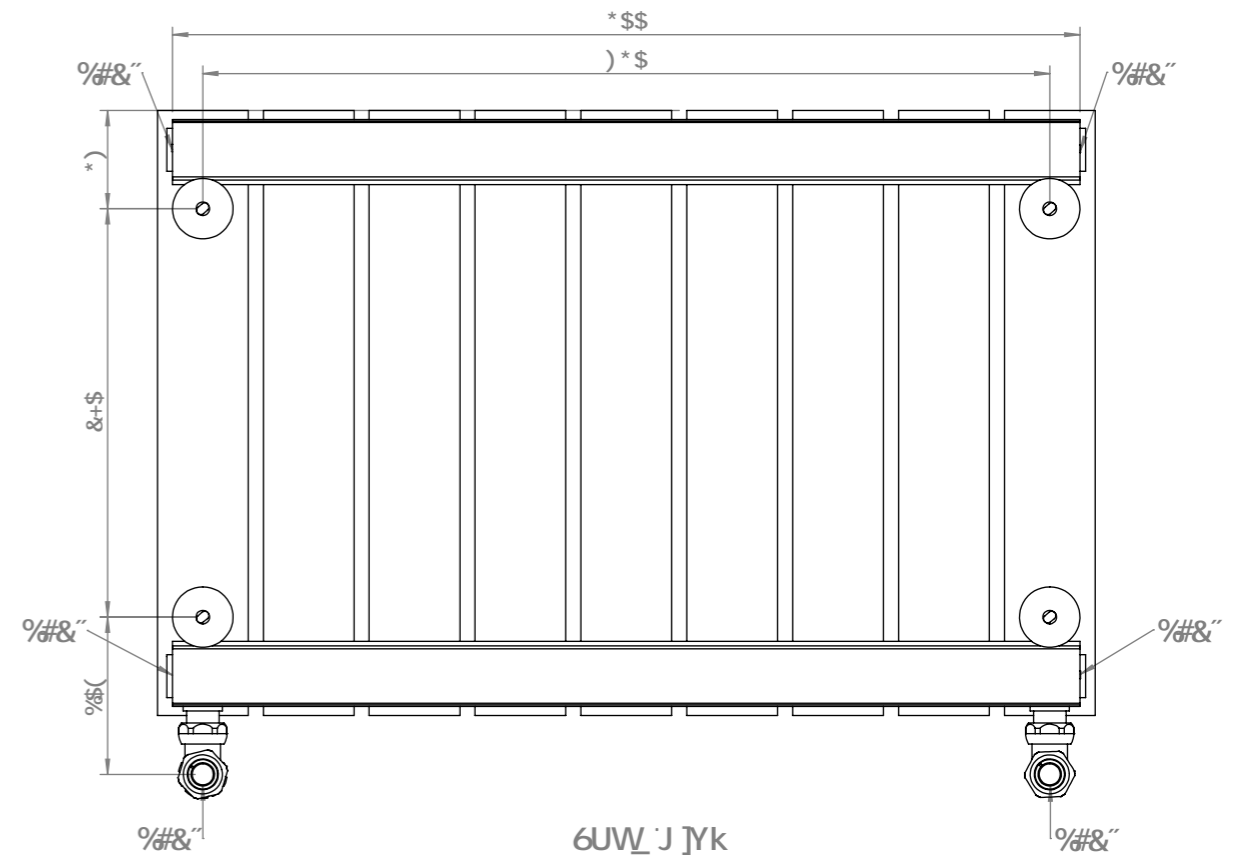
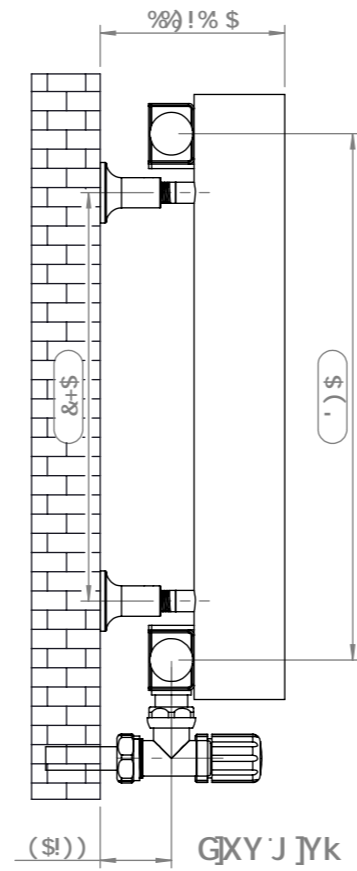
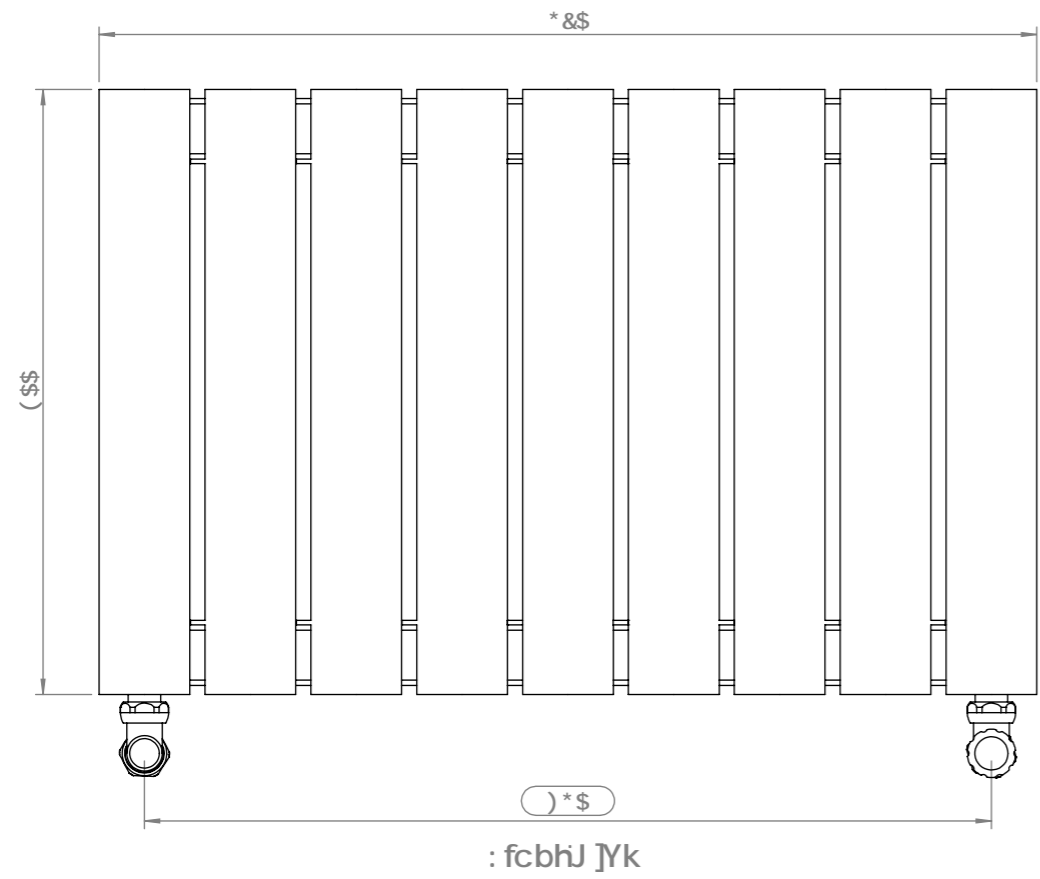

bgU`Uhcb'5WVYgc fJYg`

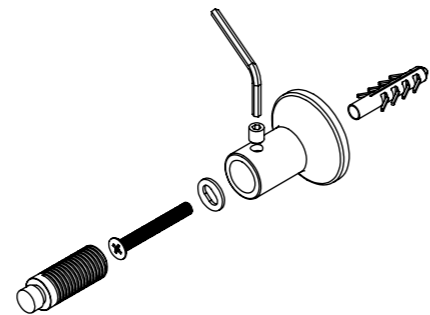
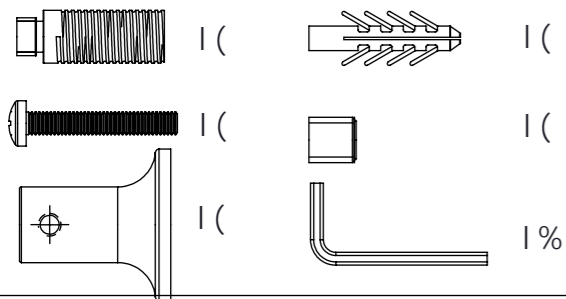

:]h['Dcgh]cb.

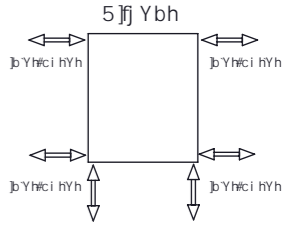

Qh/Oa ^} .a } Ae^/A {
 T æÉY [\a *AU!^.. \^AMF€AOæ
 T æÉY [\a *A^ {] |æ |^MUJ »O
 Q |^AU q^AMF€AOUU

A MGH=7!9'(%\$

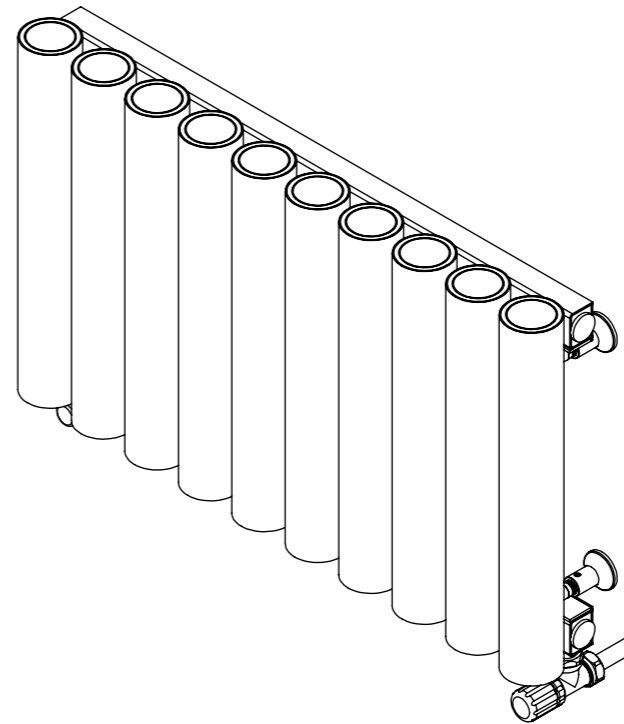
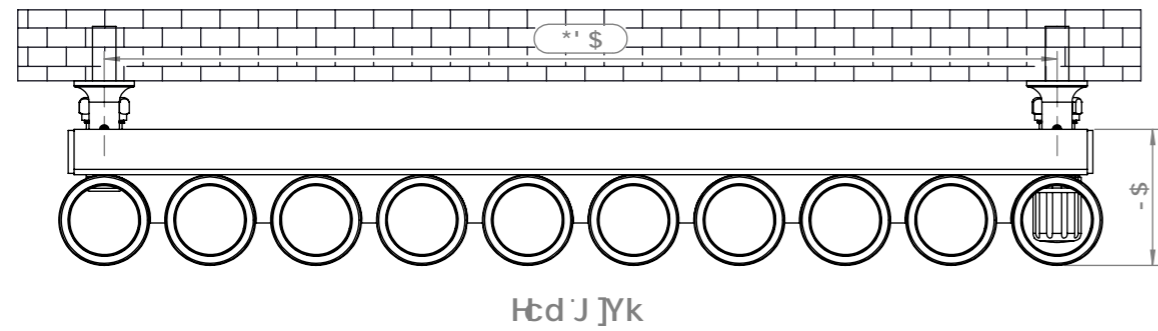
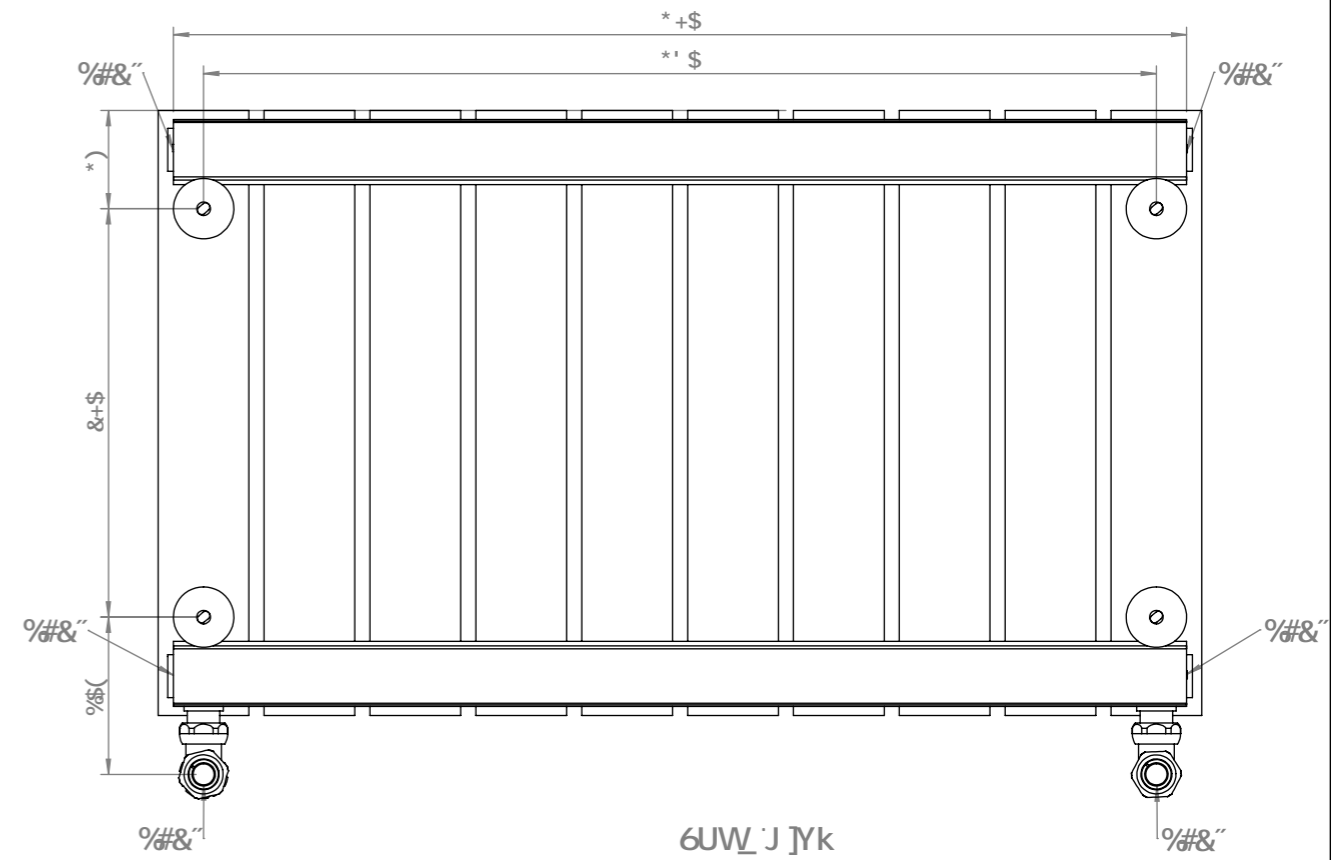
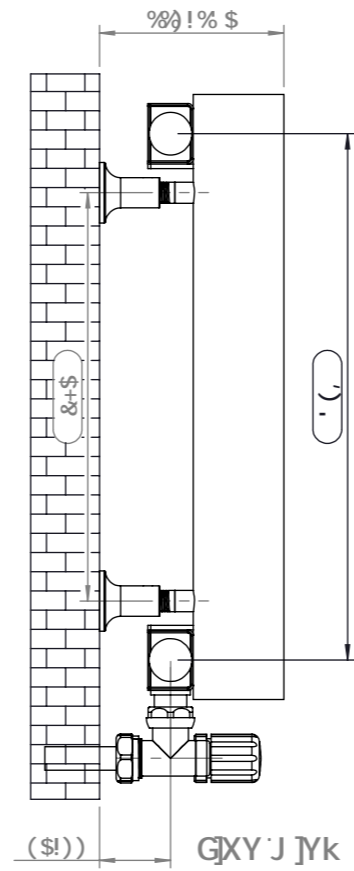
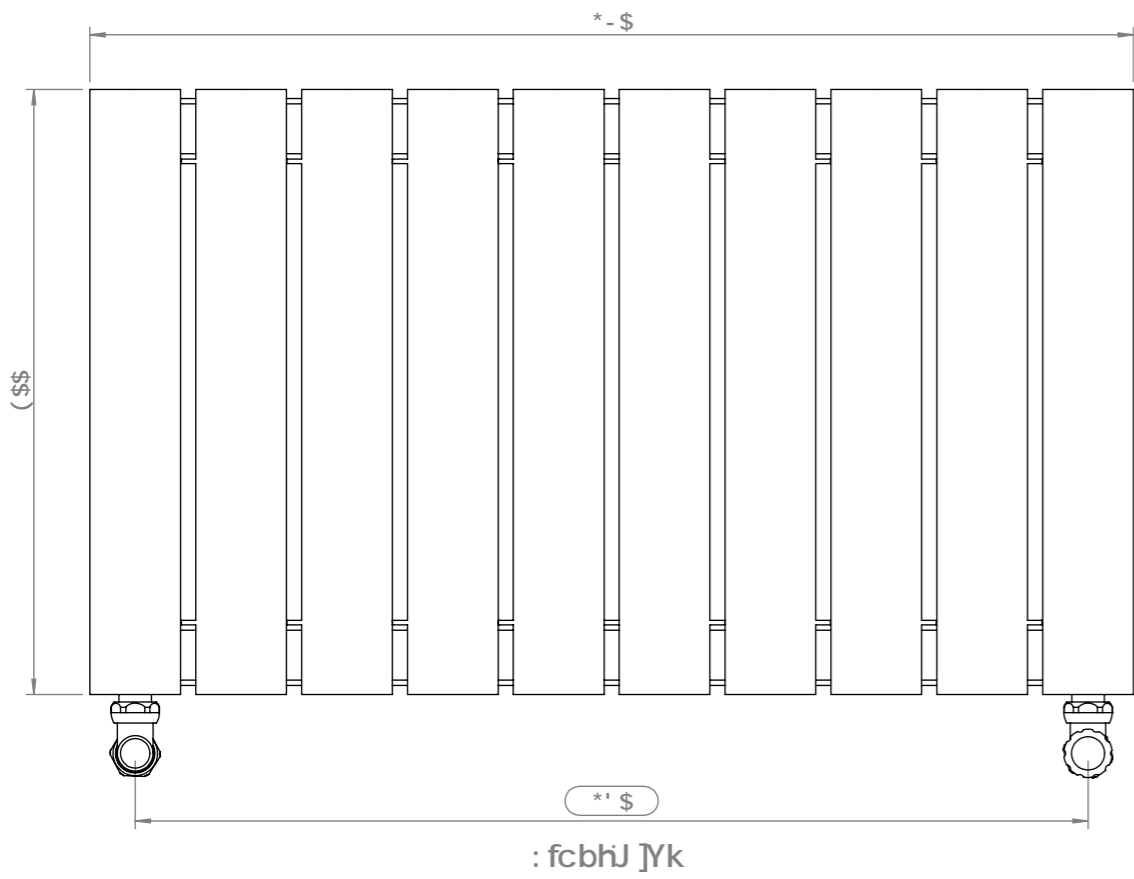

~bgtU~Uhjcb'5WVYgc]Yg'

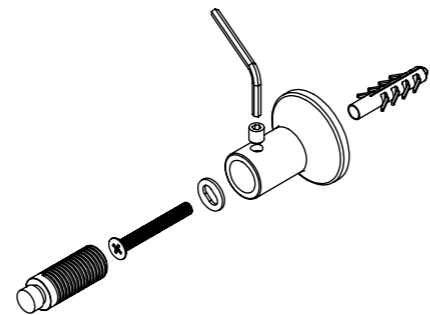
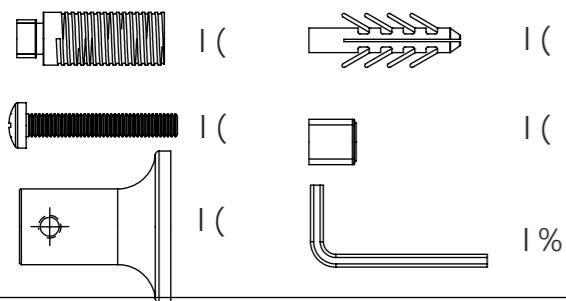

:]h]b['Dcgh]cb.

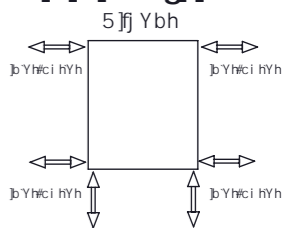

Qh/Oa ^} a } Ae^/a A {
T æÉY [\! a * AU!^•• \^AMF€AOæ
T æÉY [\! a * A/_]!æ \^MU! »O
Q\^AU q^AMF€AOUU

MYSTIC-E 412

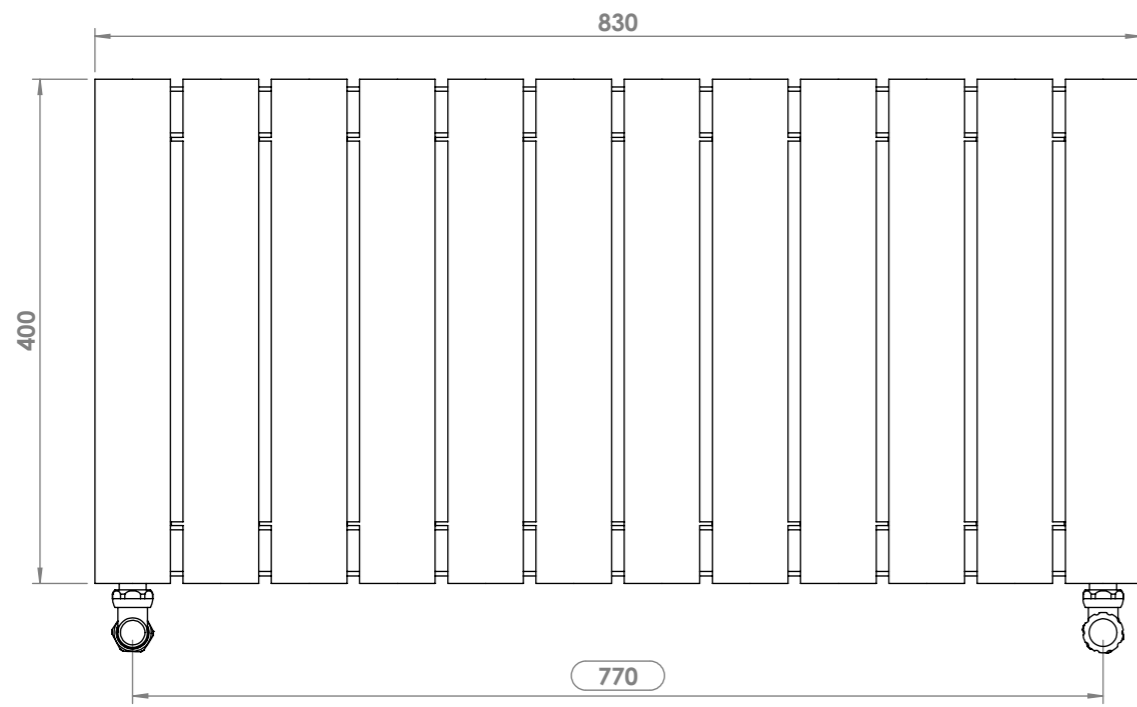

Front View

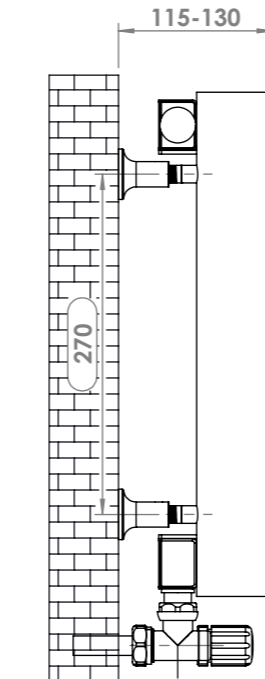

Side View

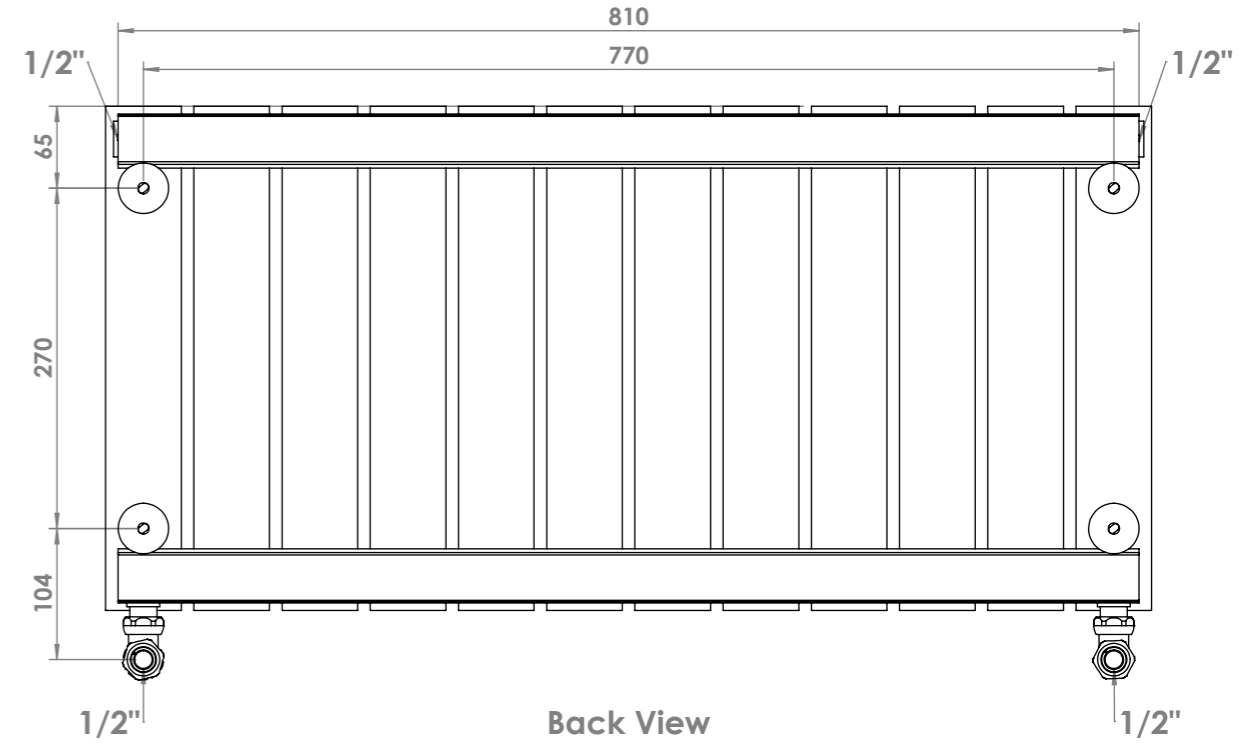

Back View

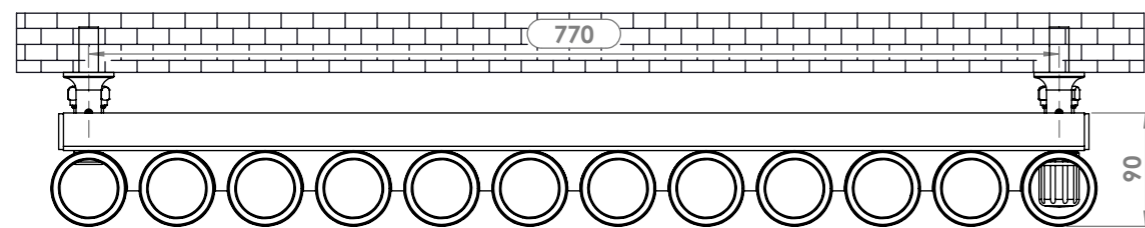

Top View

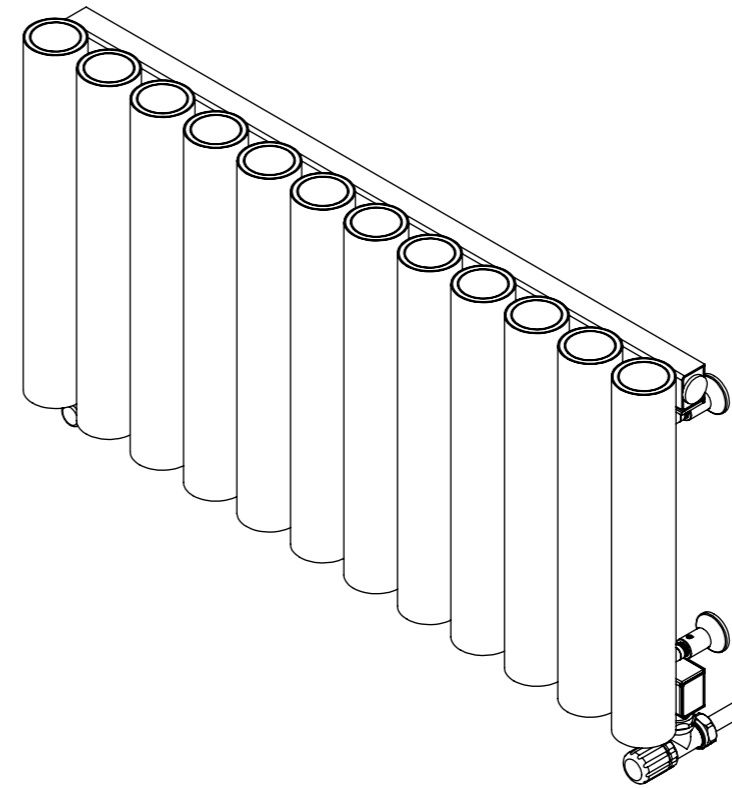

Installation Accesories:

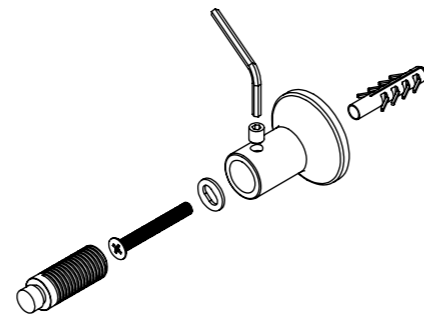
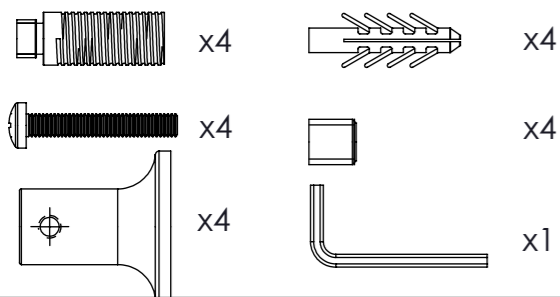

Fitting Position:

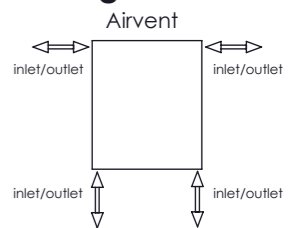

All Dimension are in mm
 Max.Working Pressure = 10 Bar
 Max.Working Temperature=95° C
 Inlet / Outlet : 1/2" BSP

A MGH=7!9'(%/

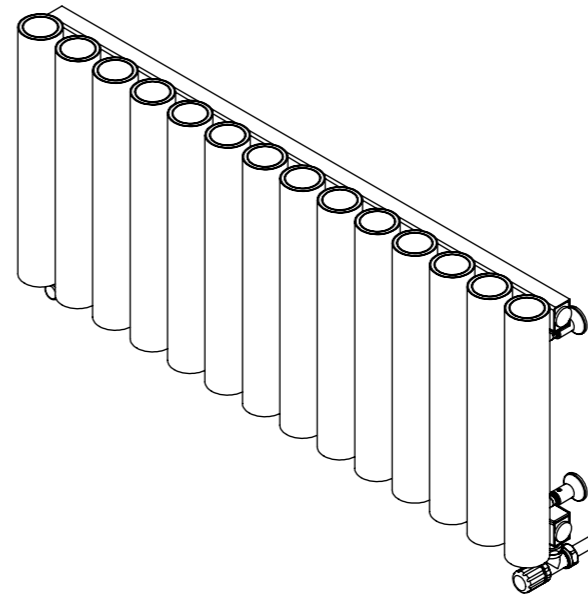
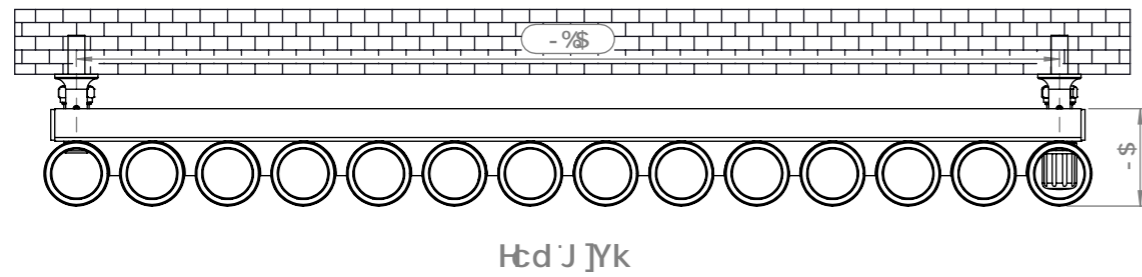
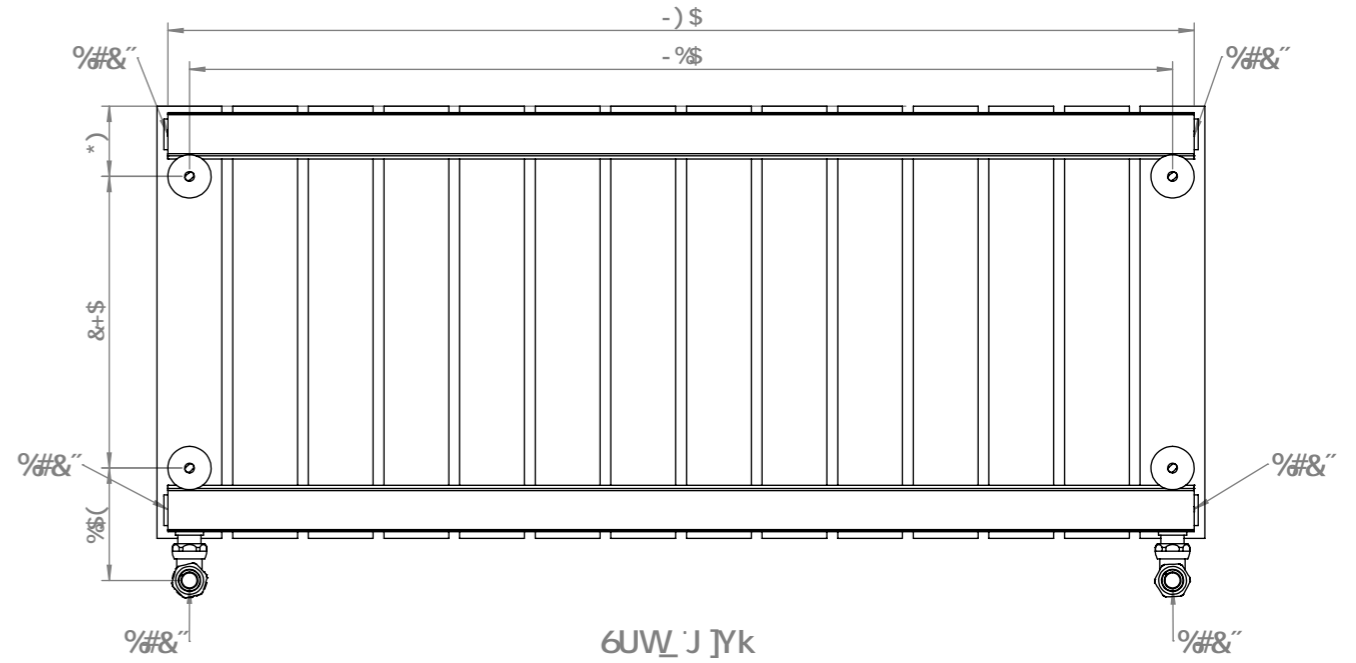
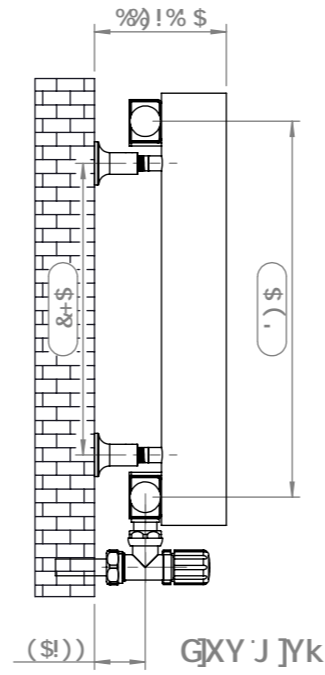
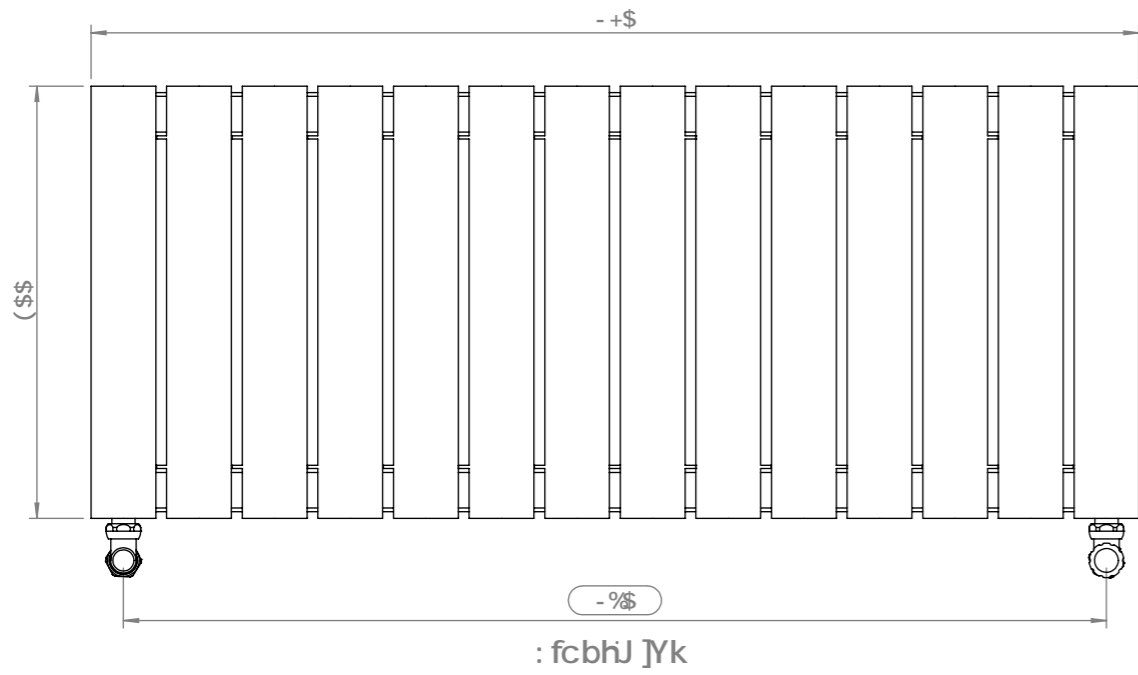

•bgtU`Uhjcb'5WVYgc fJYg`

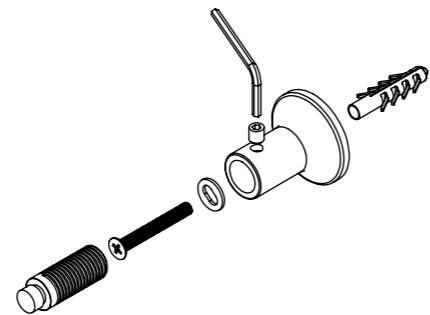
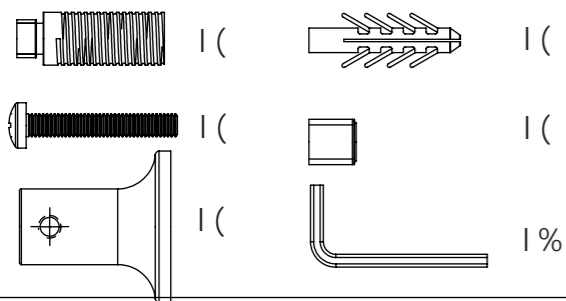

:]hpb['Dcgh]cb.

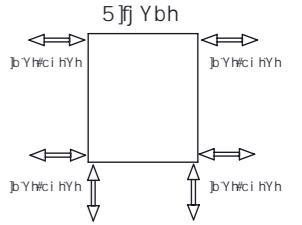

Qh/Oa ^} •a } Ae^/A {
 T æÉY [\a *AU!•• ^AMFEOæ
 T æÉY [\a *A^ {]!æ]^MUJ »O
 Q| ^AU q^ AMFEOUU

A MGH=7!9 (%*

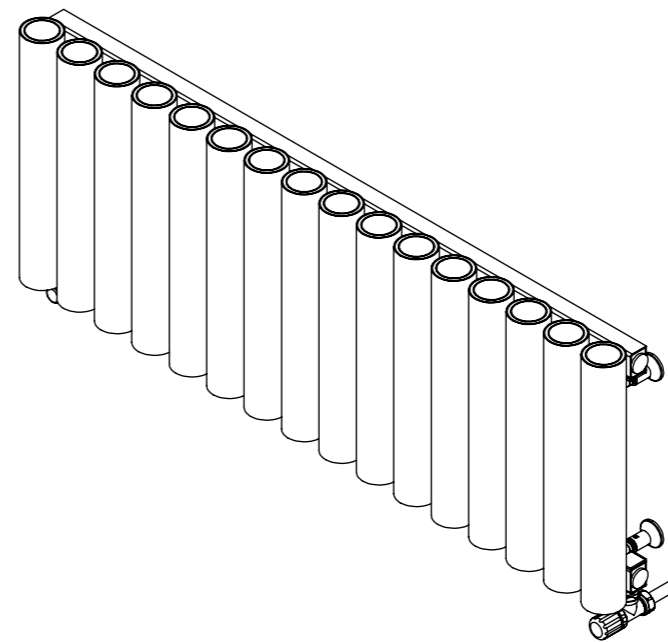
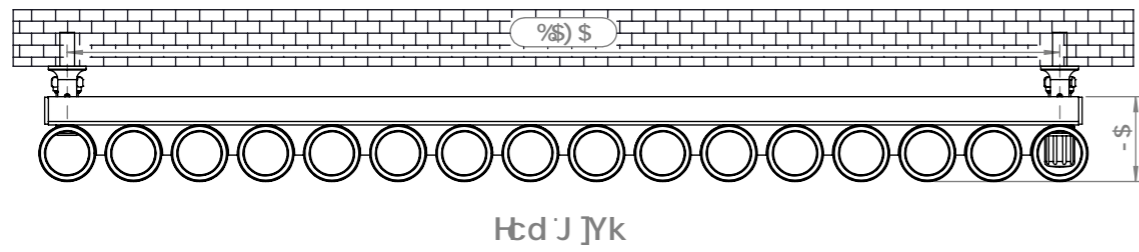
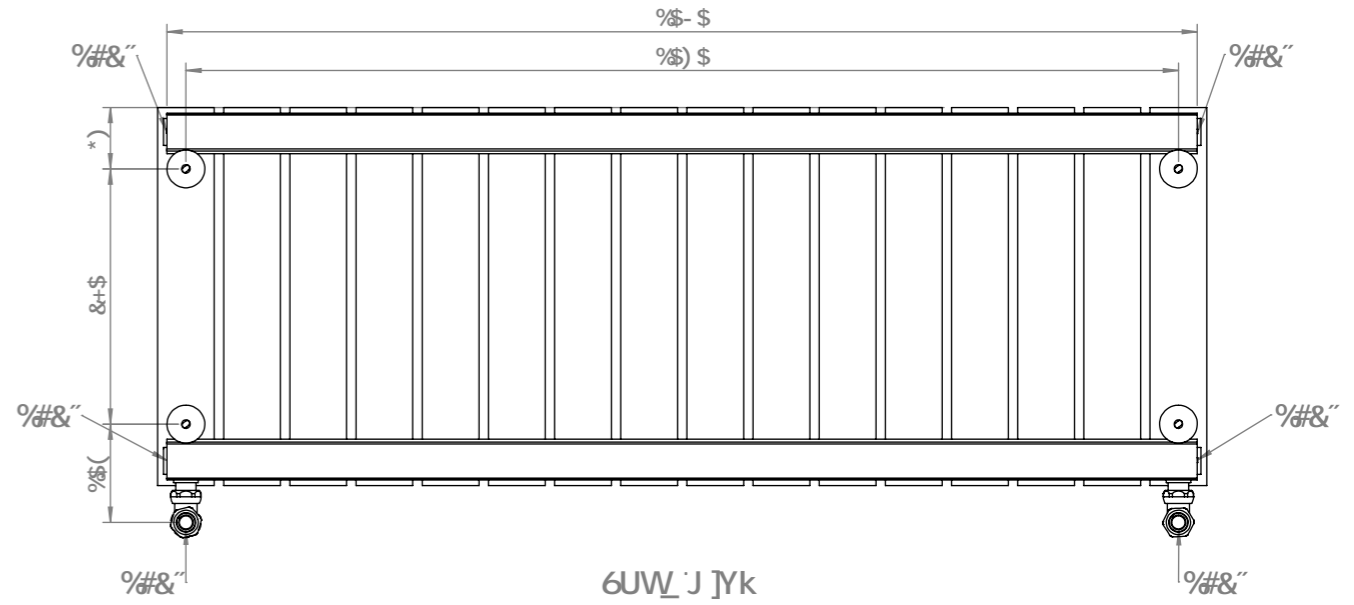
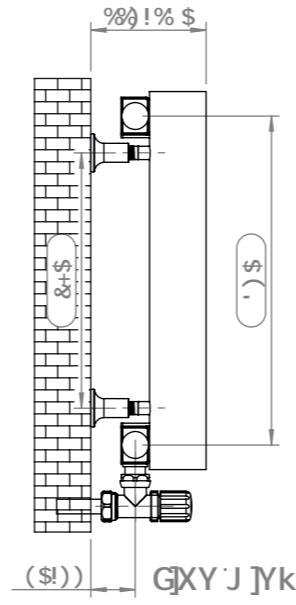
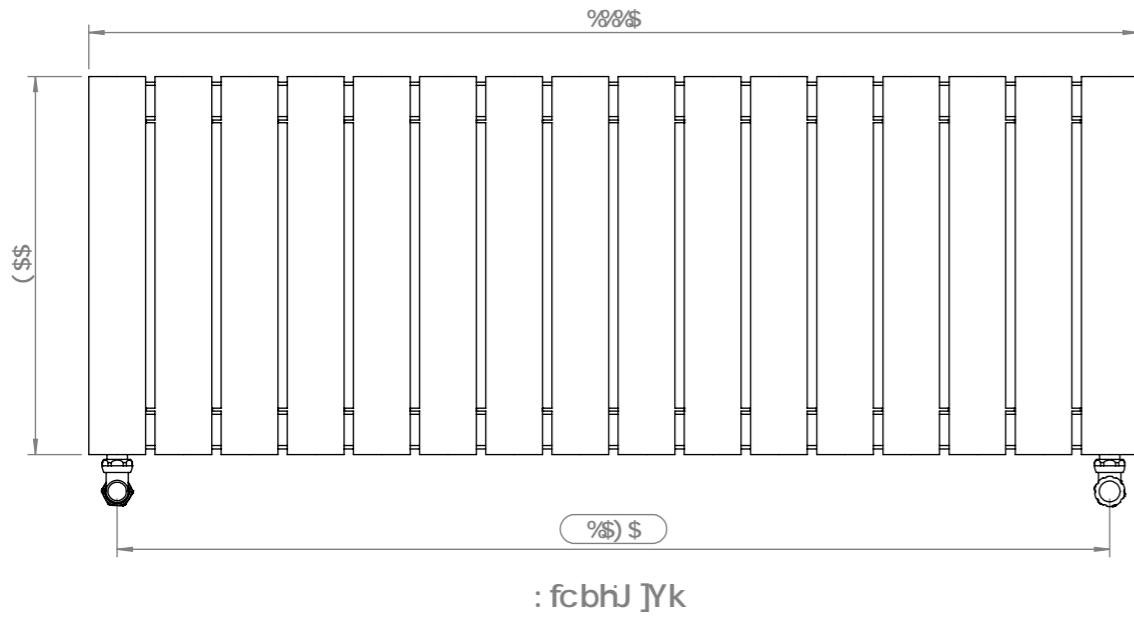

bgU~Uhcb'5WVYgc fYg'

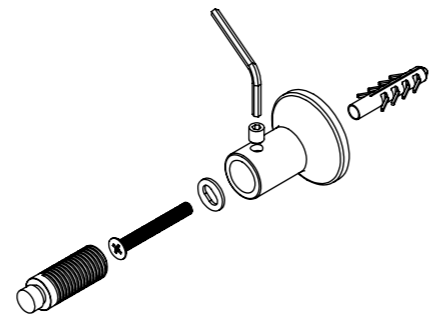
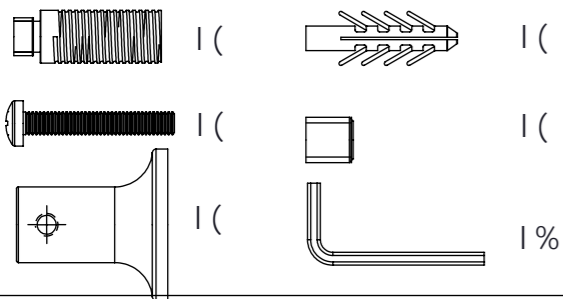

:]h['Dcg]hcb.

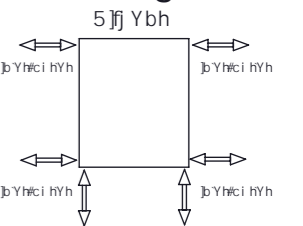

Qh/Aa ^ } a } Ae^/a A {
T æÉY [\ a * AU: ^ . ^ ^ AMEAOæ
T æÉY [\ a * A^ \] : æ] ^ MU] » O
Q | ^ a U q ^ a MFEAYOUU

A MGH=7!9 *\$)

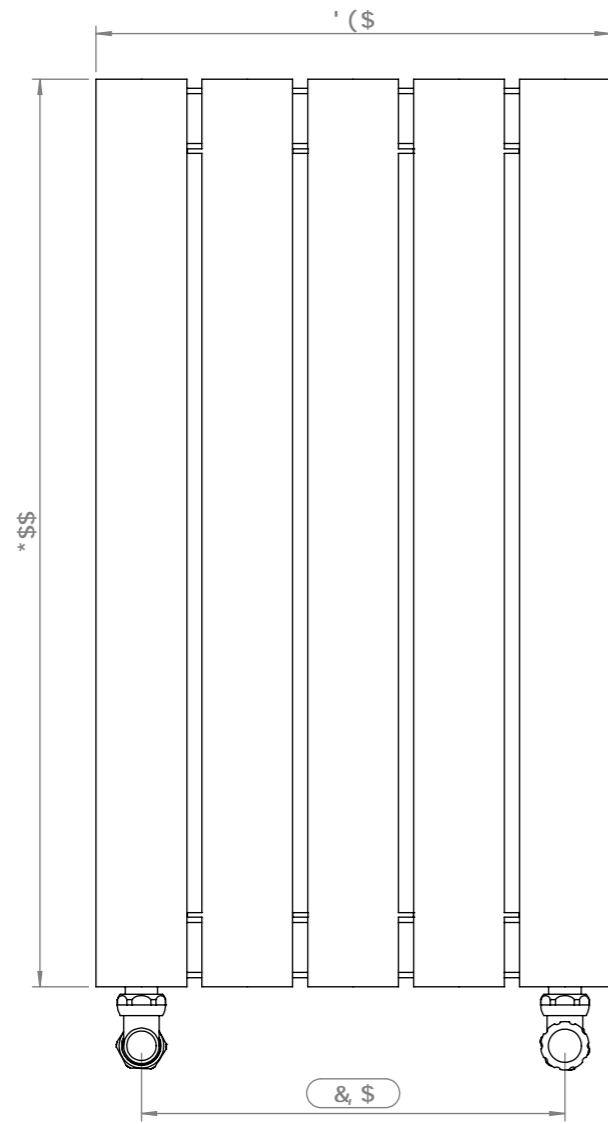

: fcbhJ JYk

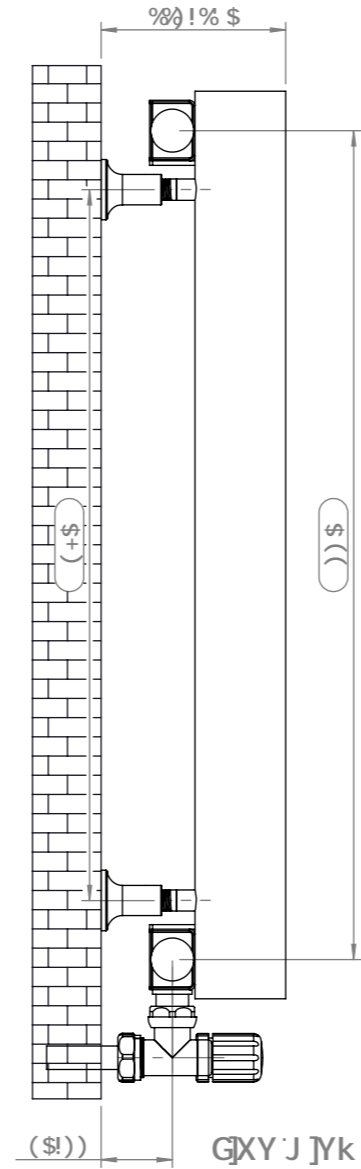

GjXY J JYk

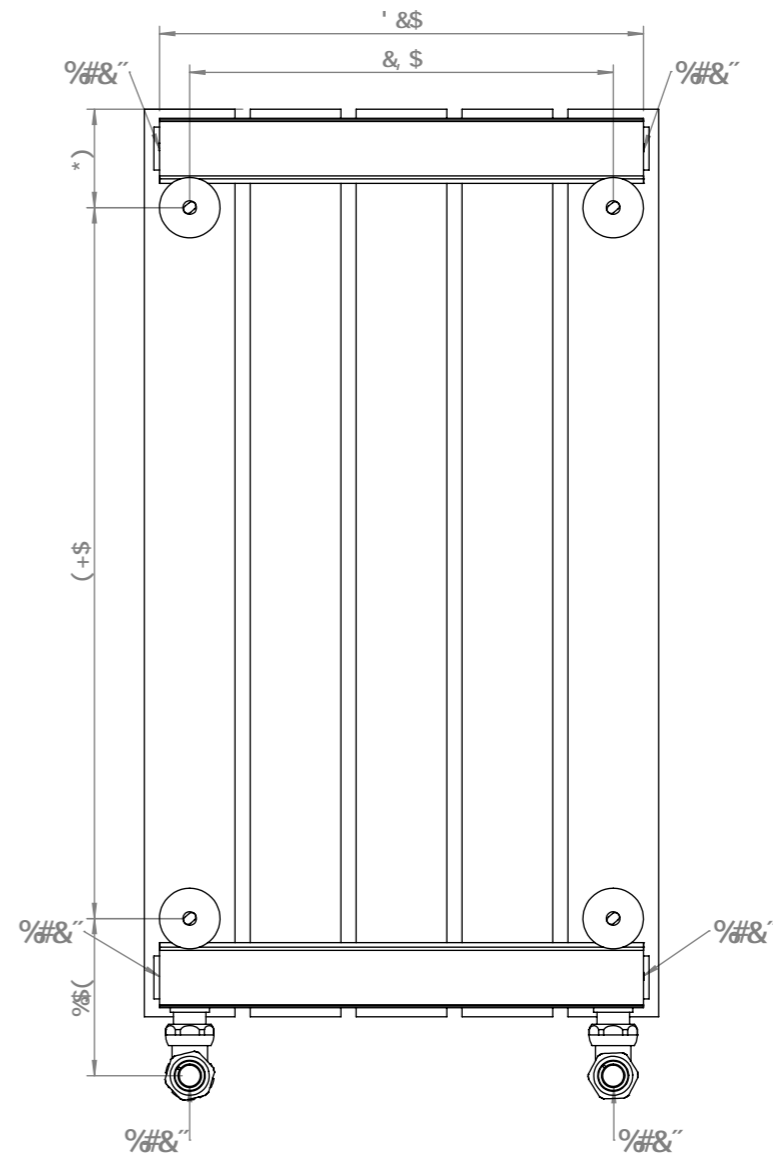

6UW J JYk

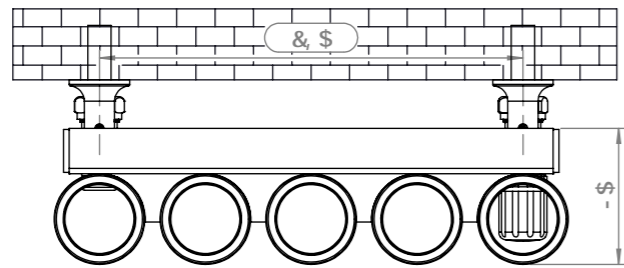
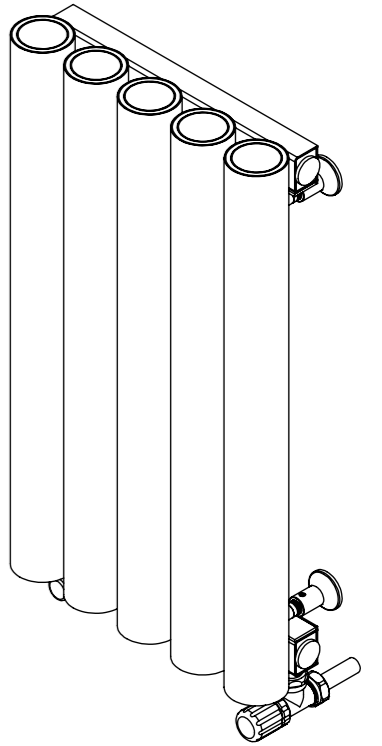

Htd J JYk

⊕gU`Uhcb'5WVYgc fJYg`

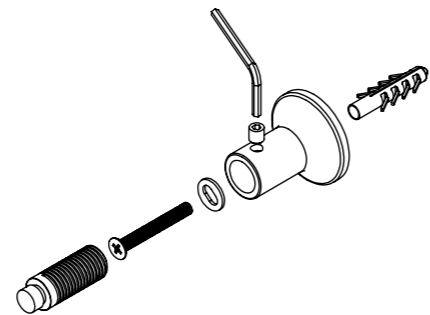
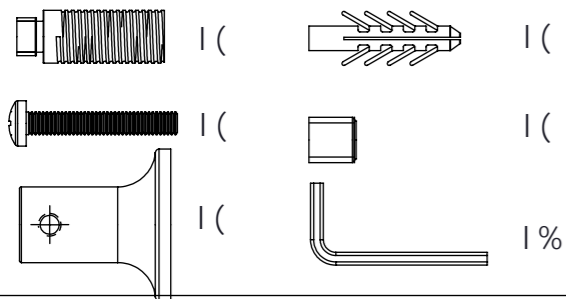

:]hb['Dcgh]cb.
5]j Ybh

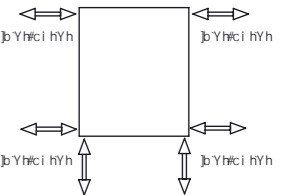

Qh/Aa ^} a } Ae^/A {
T æÉY [\a *AU:•• ^AMFEOæ
T æÉY [\a *A^ }]!æ]^MJ! »O
Q| ^AU q^ ^MFEOUU

MYSTIC-E 606

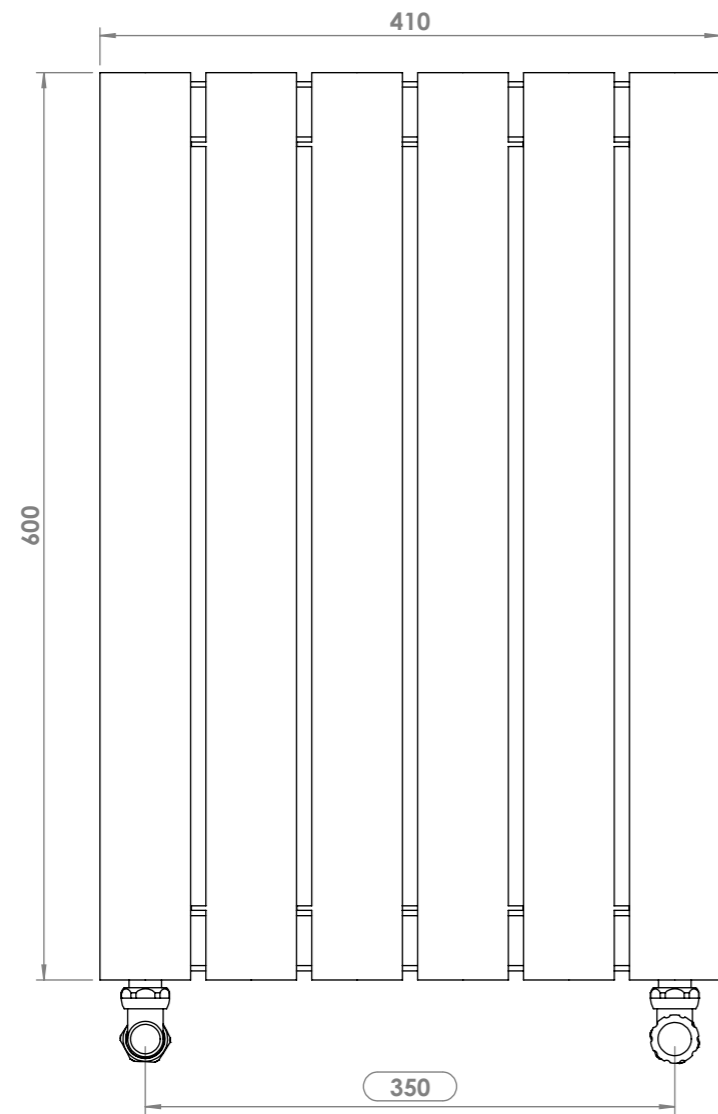

Front View

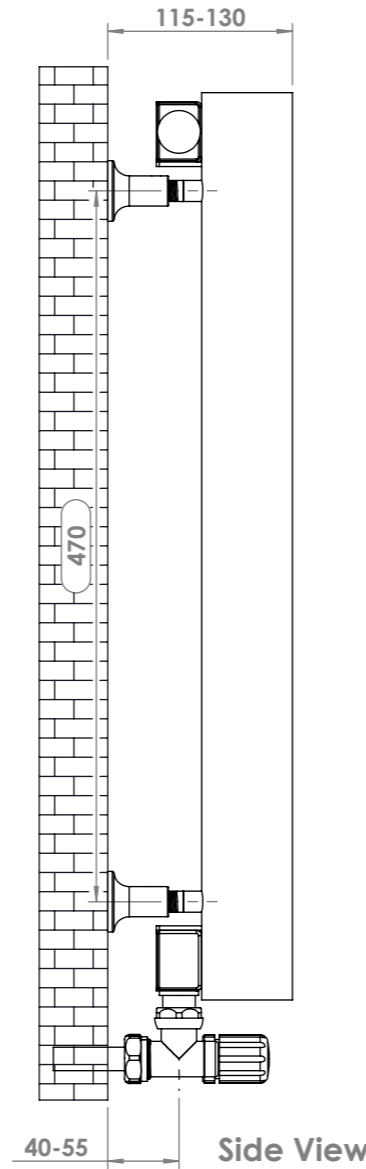

Side View

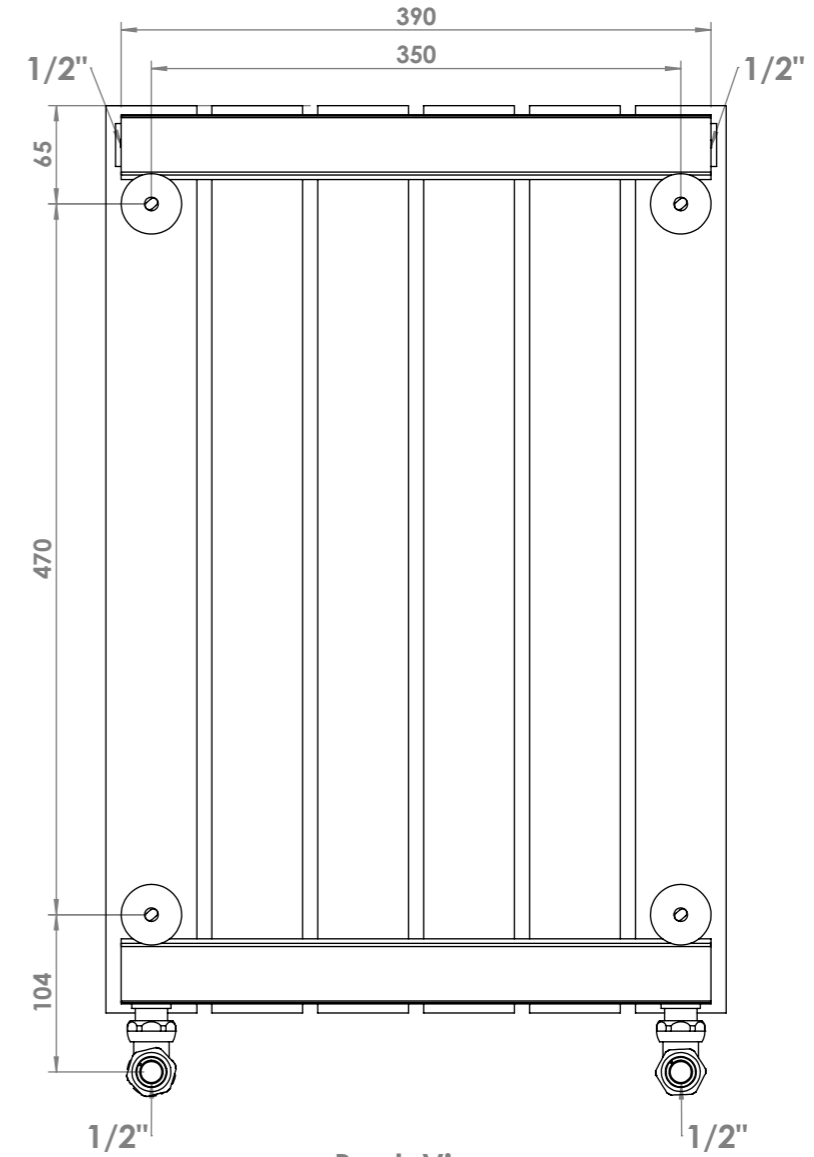

Back View

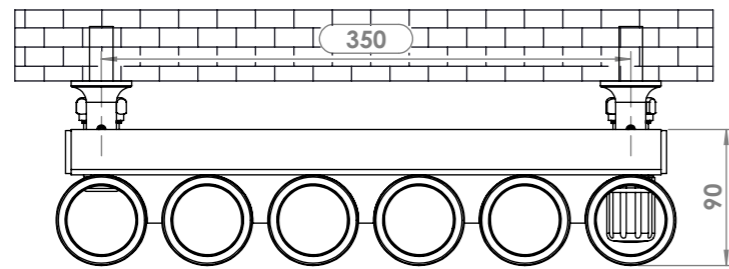

Top View

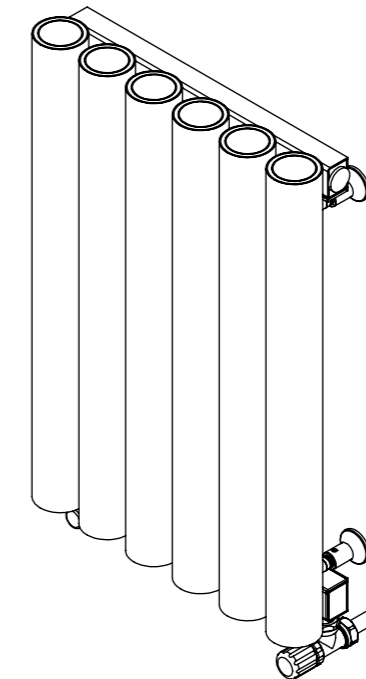

Installation Accesories:

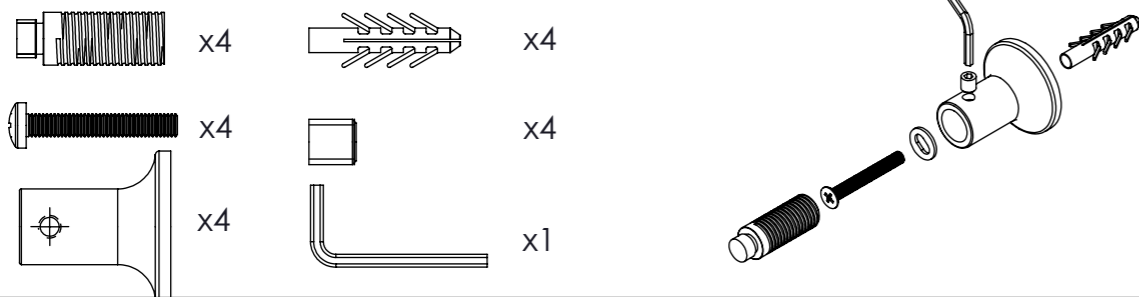

Fitting Position:

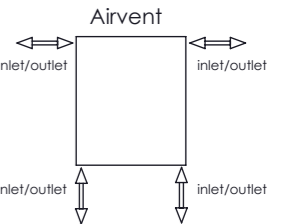

All Dimension are in mm
 Max.Working Pressure = 10 Bar
 Max.Working Temperature=95° C
 Inlet / Outlet : 1/2" BSP

A MGH=7!9*.\$+

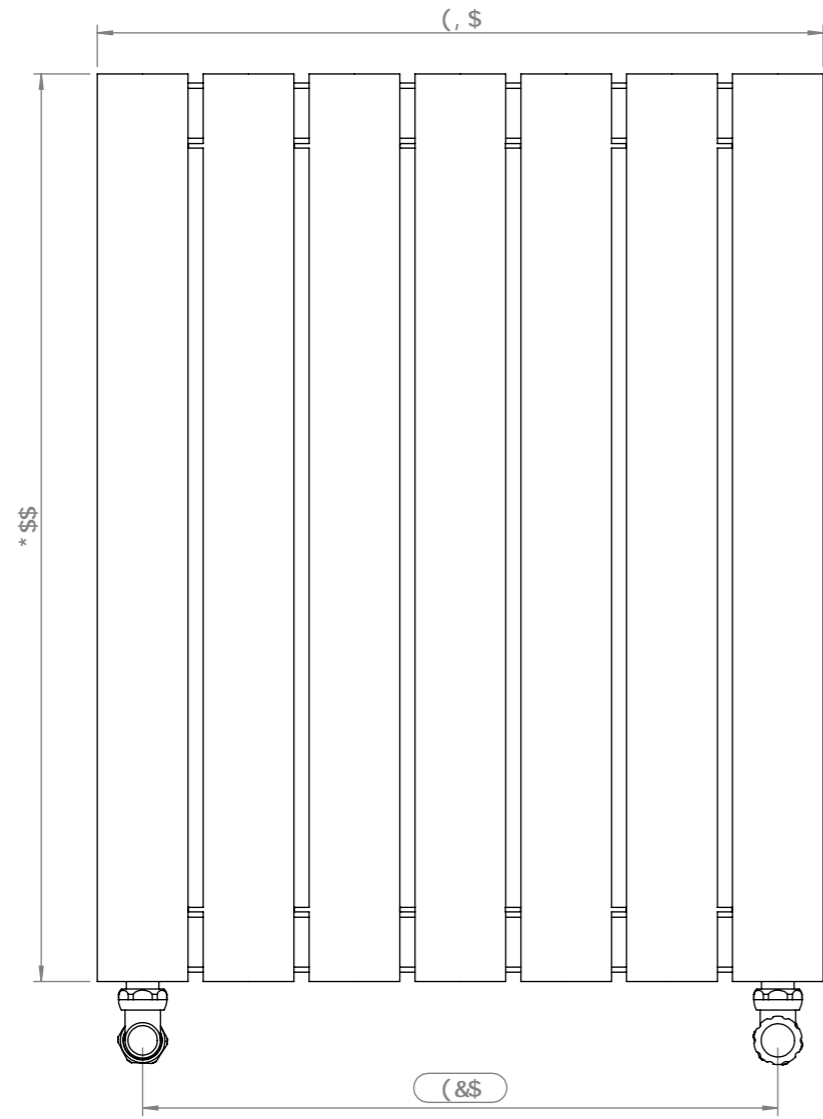

: fcbhJ JYk

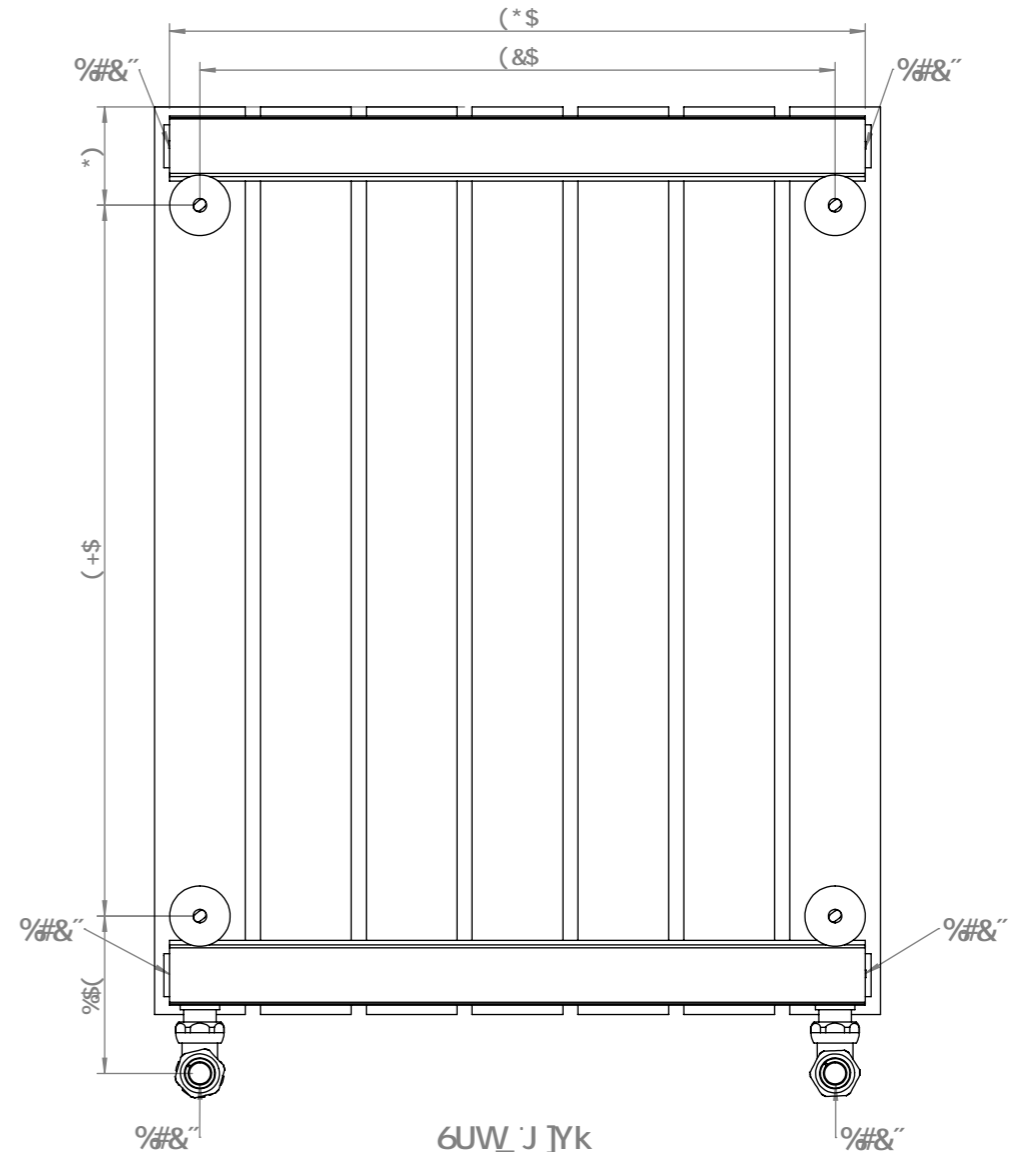
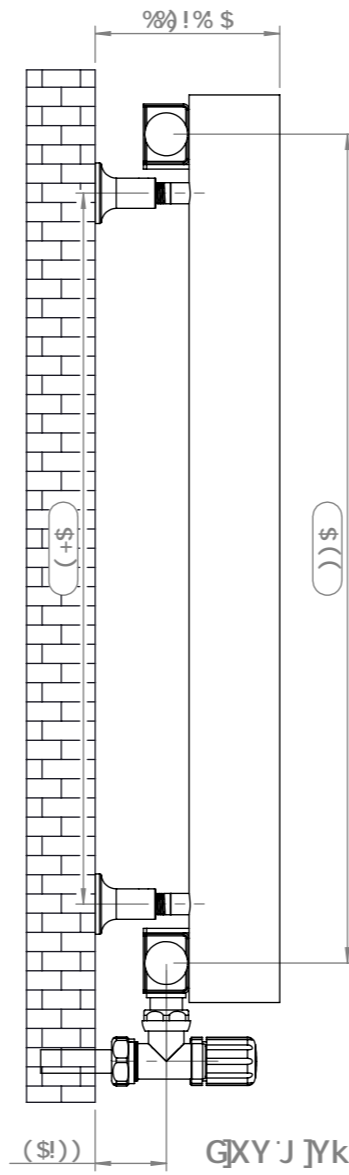

6UW_ J JYk

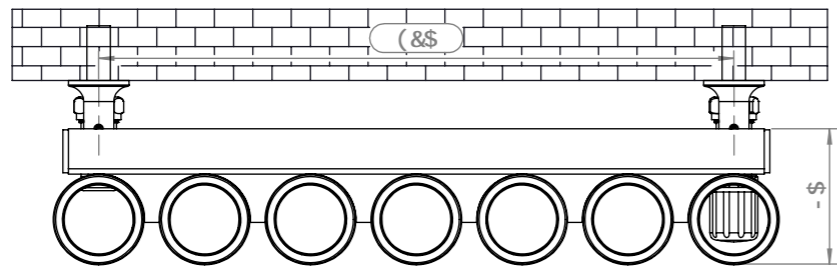

Hcd' J JYk

·bgU`Uhjcb'5WVYgc fJYg`

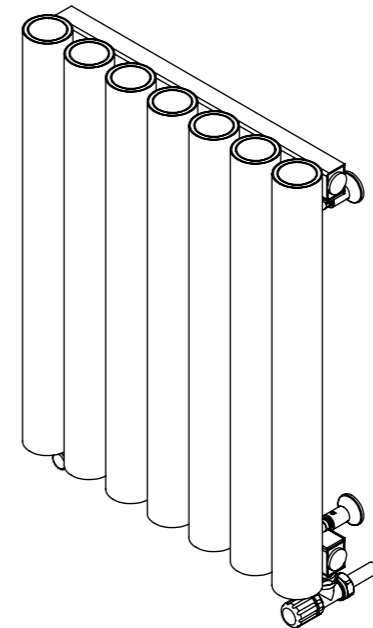
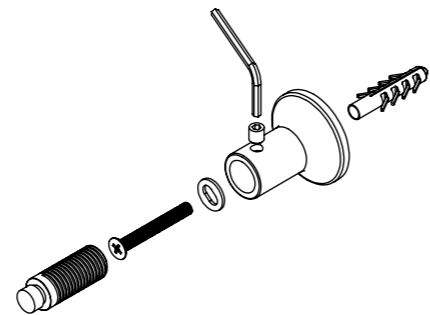
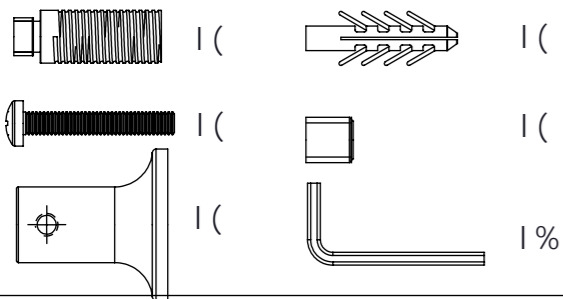

:]hpb['Dcgh]cb.

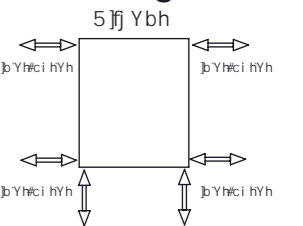

Qh/Aa ^} ·a } Aa^/A {
T aEY [\a *AU!·· ^AMFEOa
T aEY [\a *A^ {]!aE]^MJ! »O
Q| ^AU q^ AMFEOUU

A MGH=7!9 '* \$,

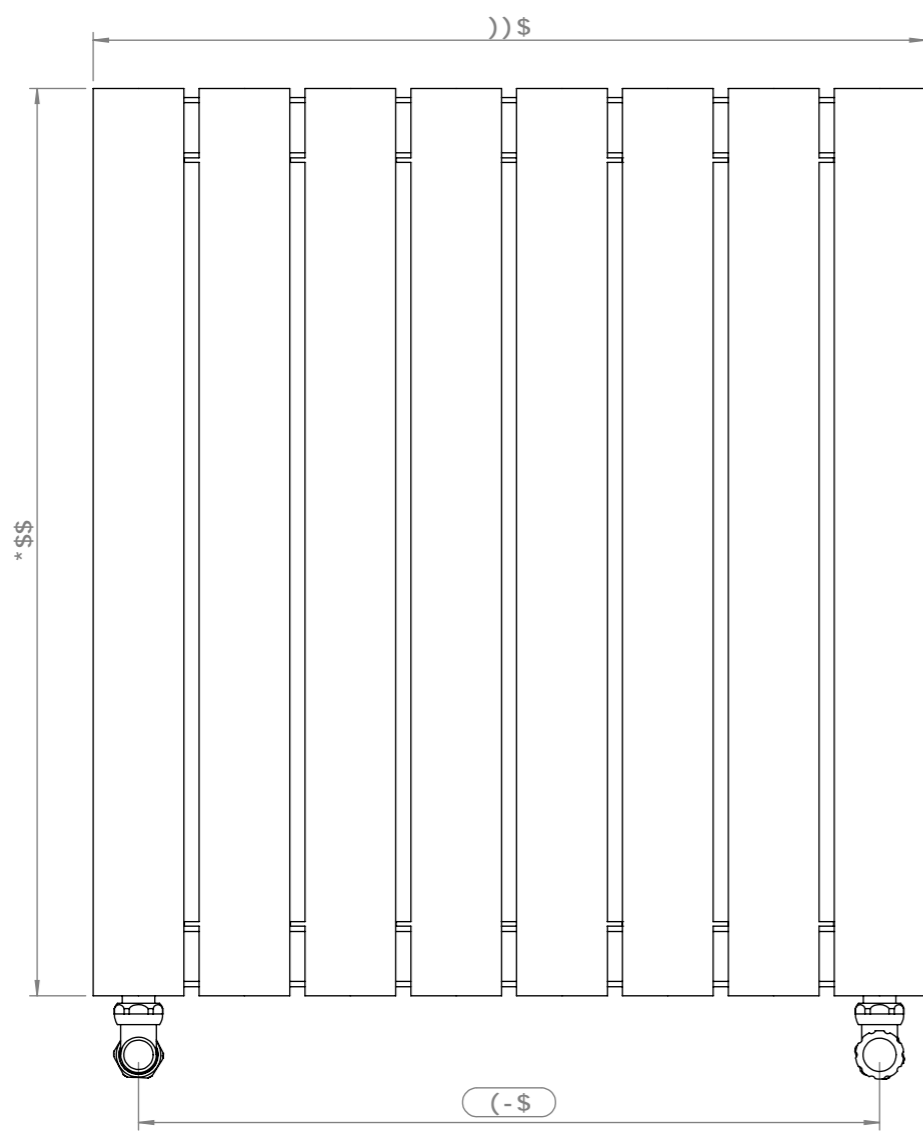

: fcbhJ JYk

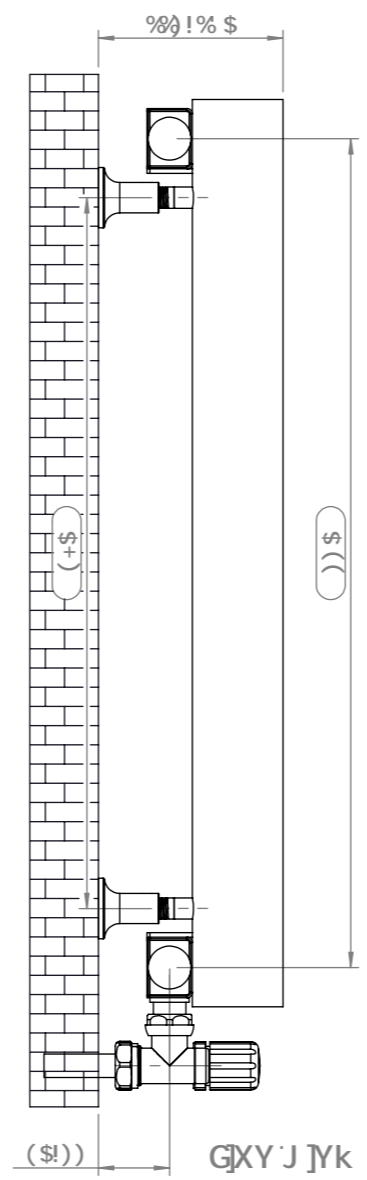

GjXY'J JYk

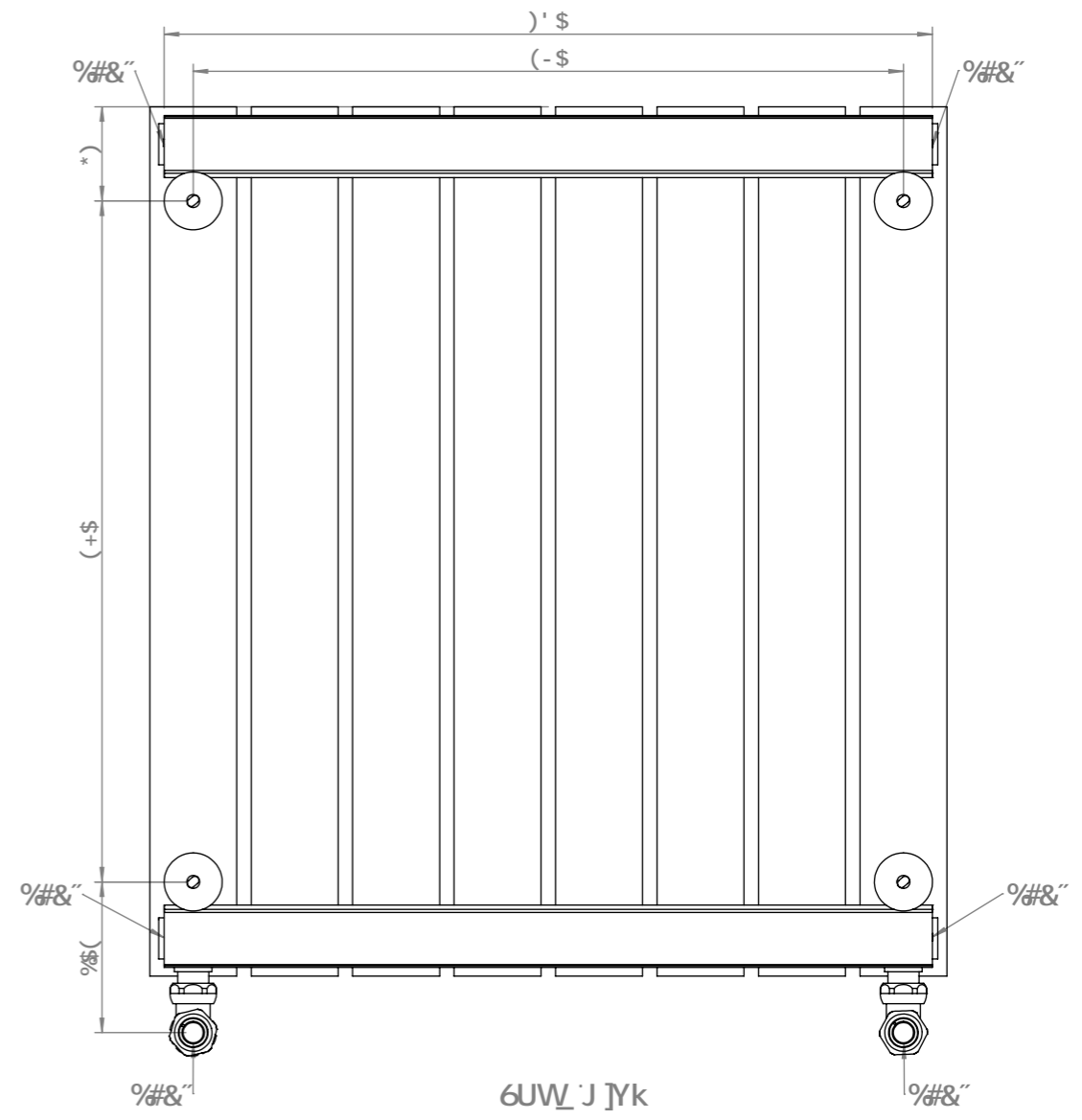



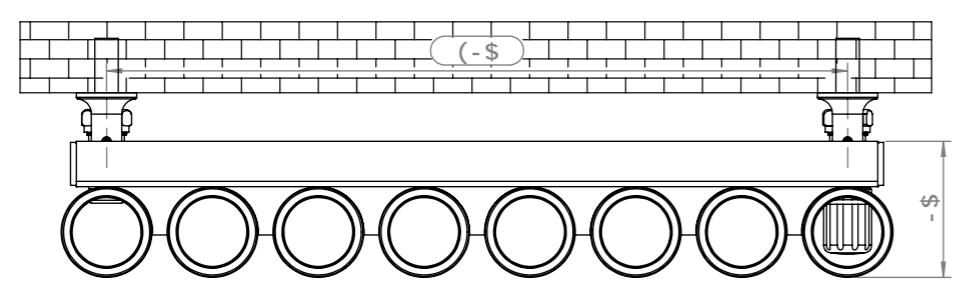

6UW' J JYk

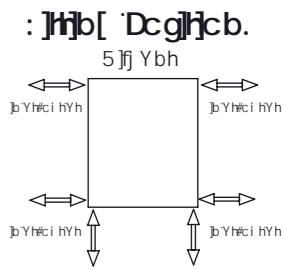
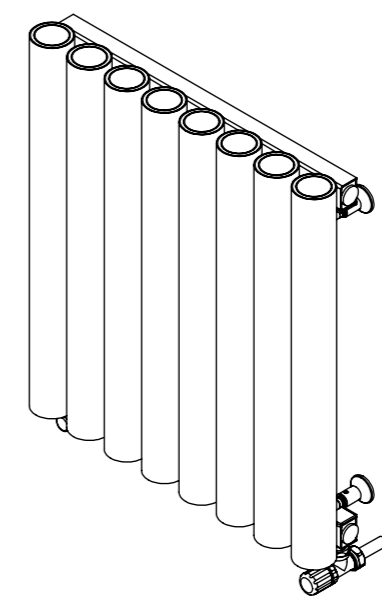

Hcd' J JYk

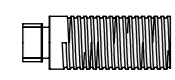

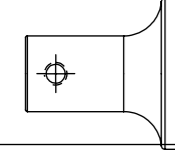
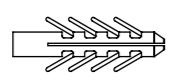
bgU`Uhcb'5WVYgc fJYg`

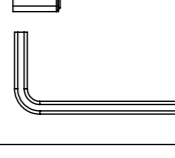
-  1 (
-  1 (
-  1 (
-  1 (
-  1 (
-  1 %

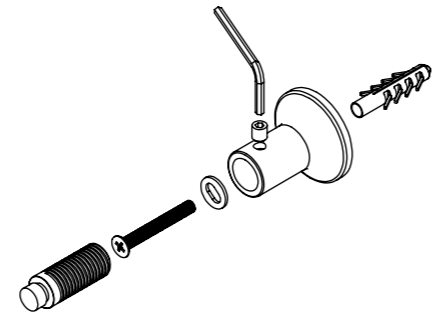

Qh/Oa ^} • a } Ae^/A {
 T æEY [\a * AU:•• ^AMFEOæ
 T æEY [\a * A^ {] |æ] ^MJ | »O
 Q | ^AU q ^ AMFEOUU

A MGH=7!9*-\$-

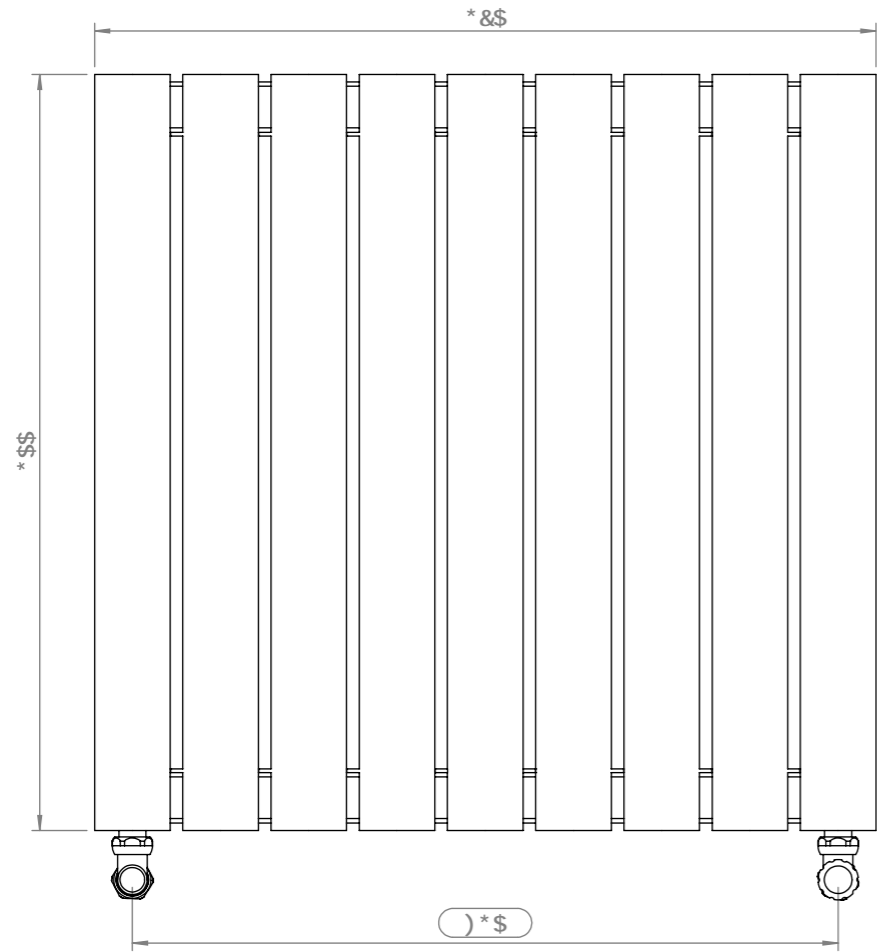

: fcbhJ JYk

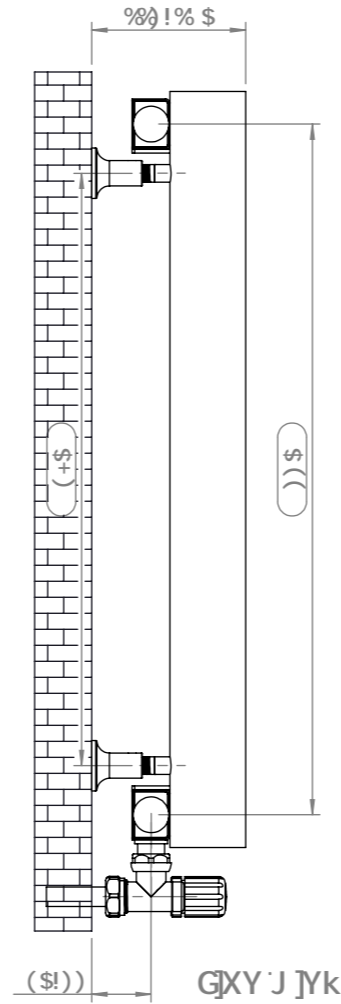

GXY J JYk

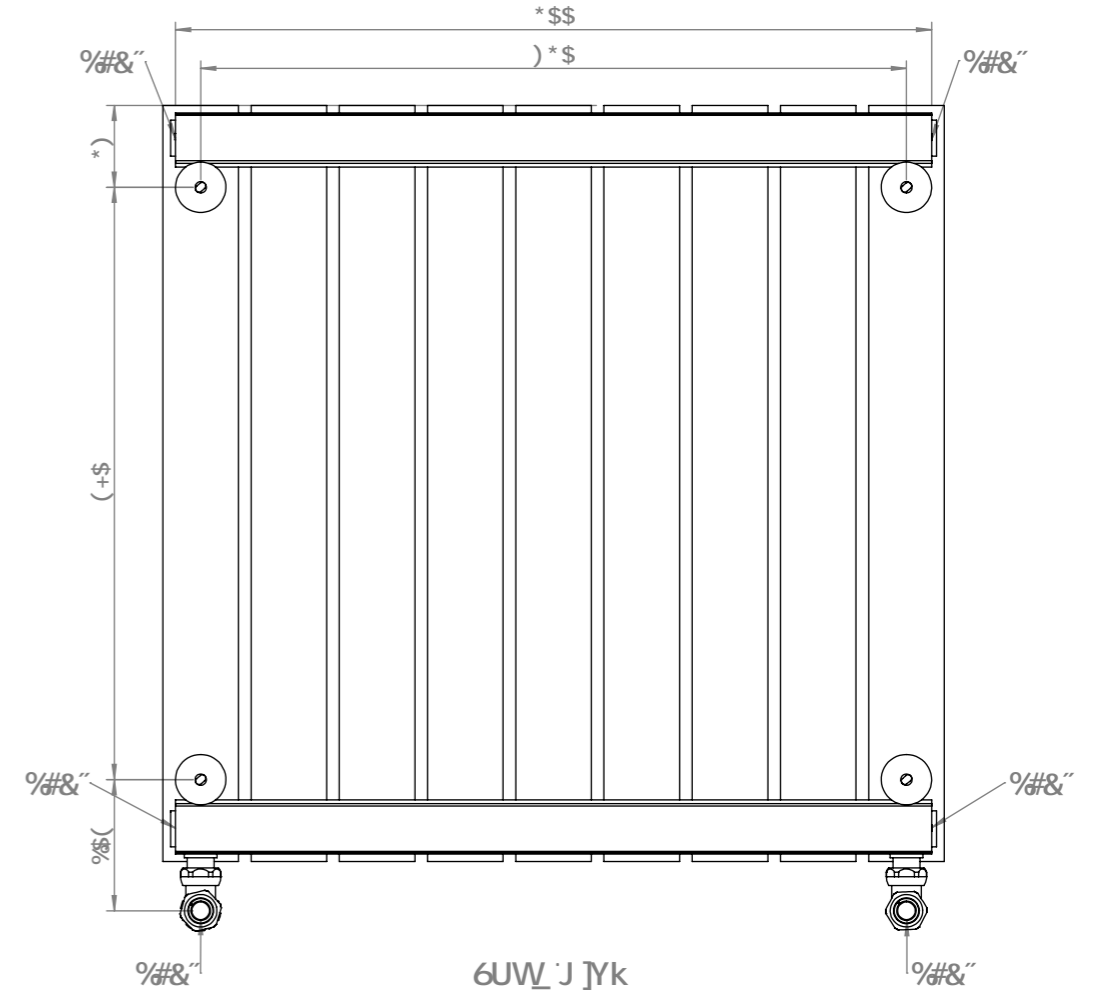

6UW J JYk

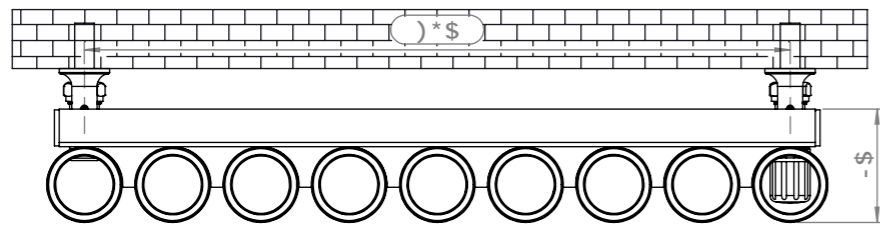

Htd J JYk

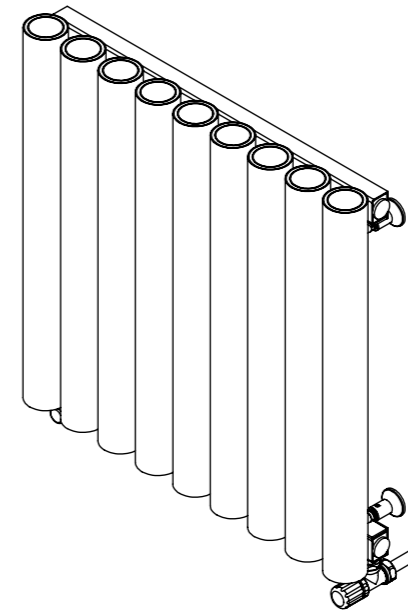

⊕bgU`Uhcb'5WVYgc fJYg`

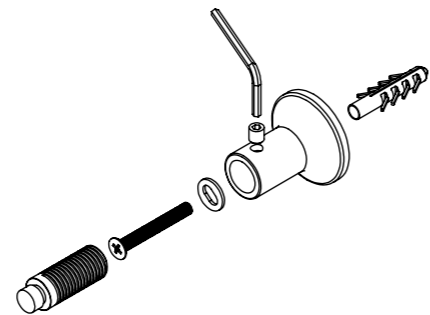
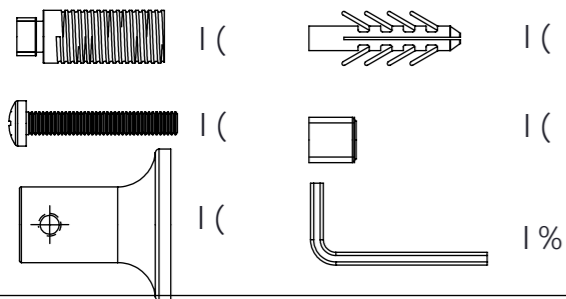

:]hpb['Dcgh]cb.

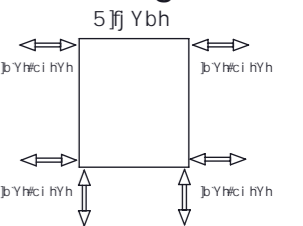

Qh/Aöa ^}•a } Æ^/Ä Ä {
T æÉY [\ä *AU;^•• \^AMF€AOæ
T æÉY [\ä *A^ {] |æ]^MJ | »O
Q | ^öAU q^öMFEöYUU

A MGH=7!9'*\$

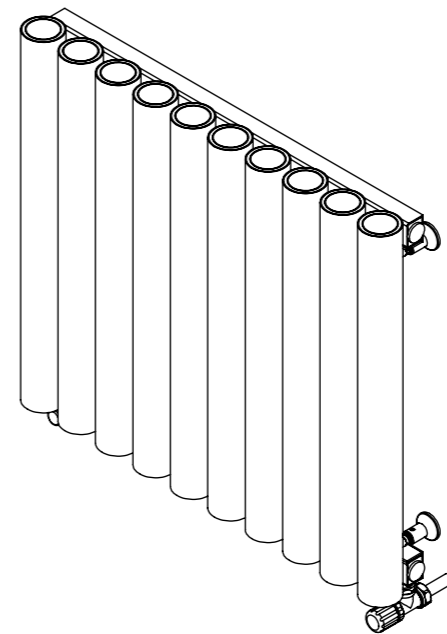
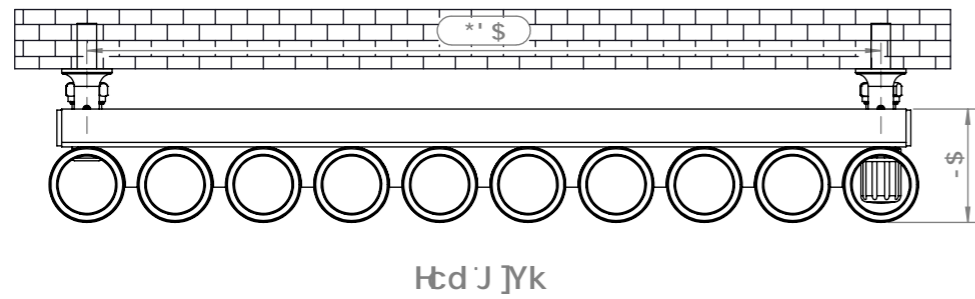
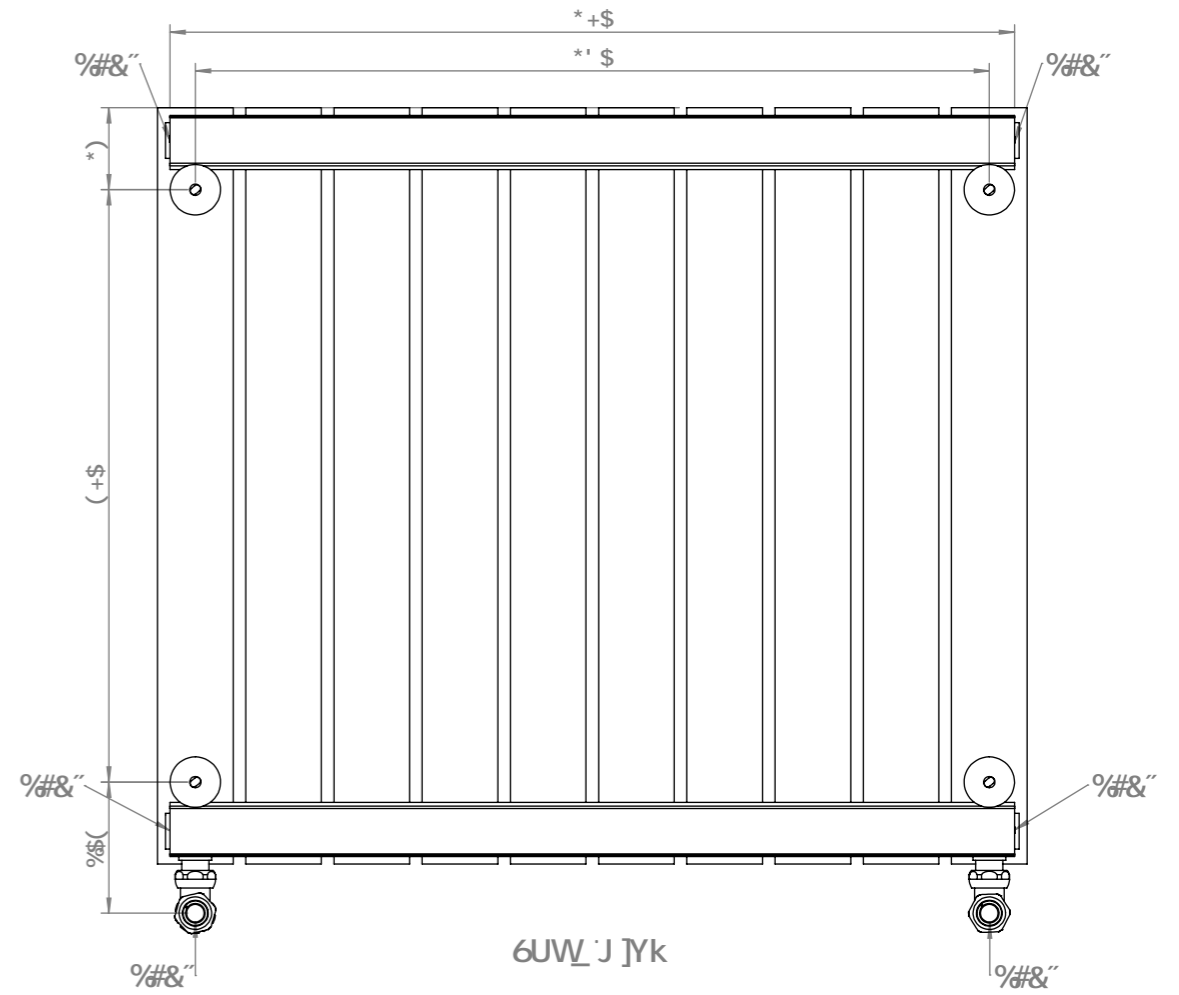
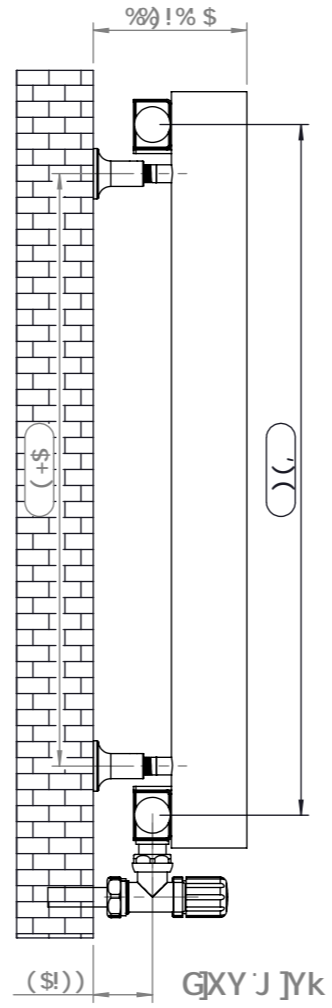
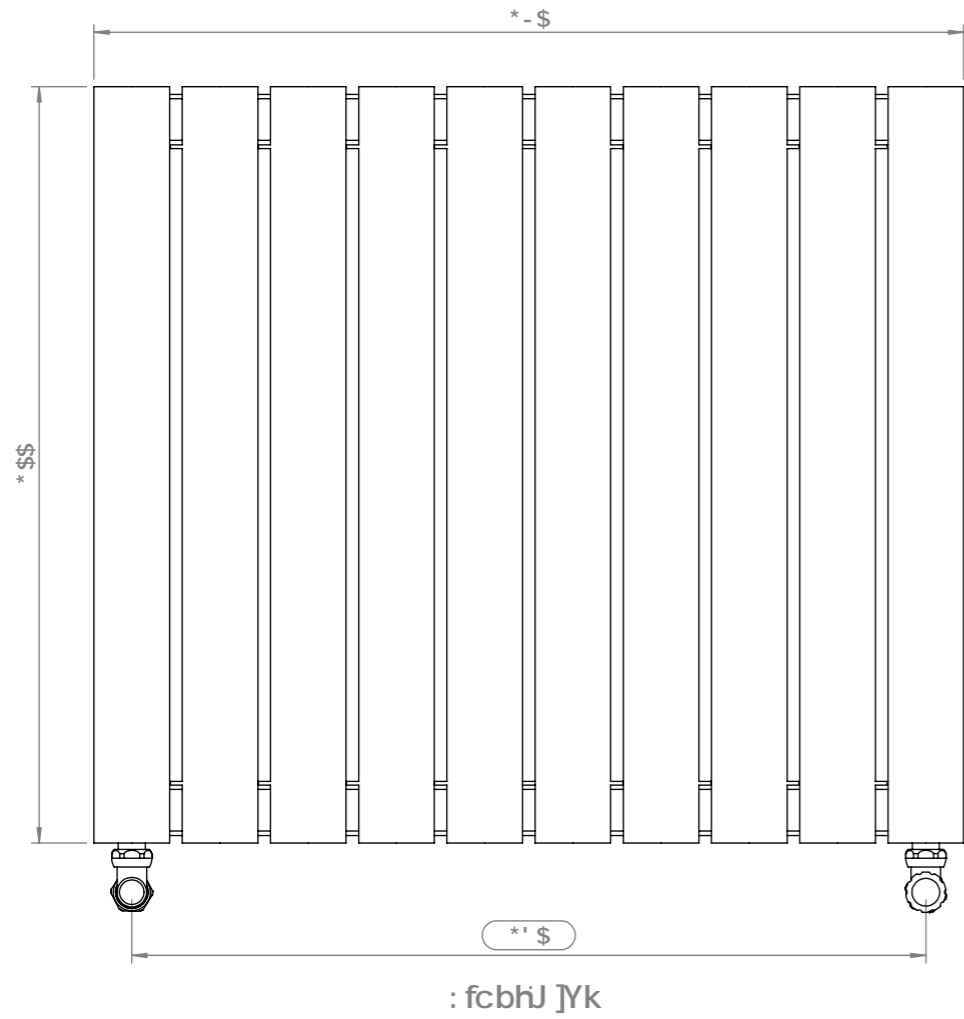

bgU`Uhcb'5WVYgc fJYg`

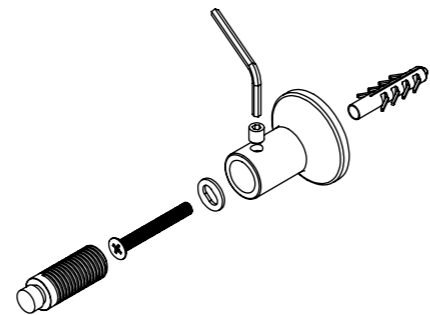
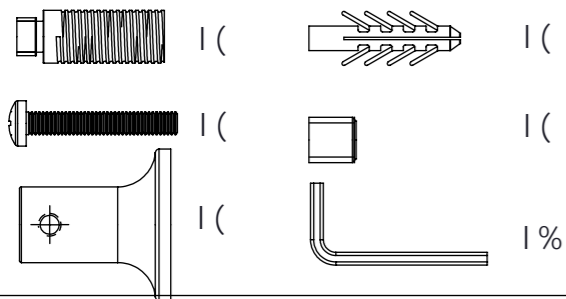

:]hb['Dcgh]cb.
5]j Ybh

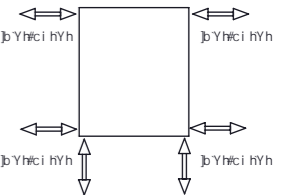

Qh/Aa ^} a } Ae^/A {
T æEY [\a *AU:•• \^AMF€AOæ
T æEY [\a *A^ \] |æ |^MUJ »O
Q |^AU q^AMF€AOUU

MYSTIC-E 612

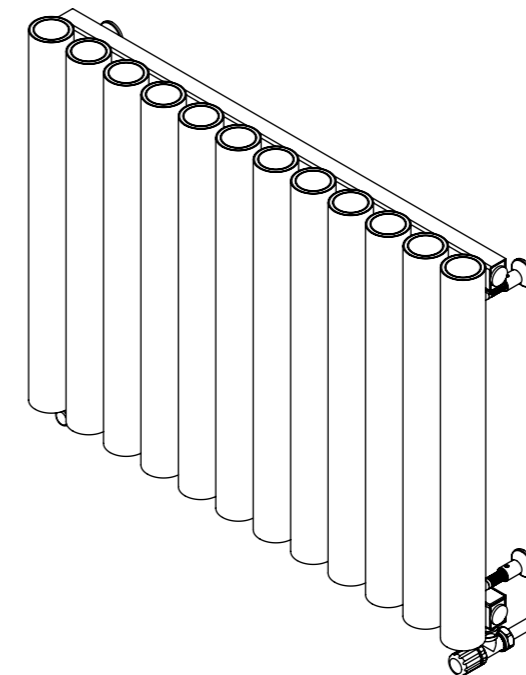
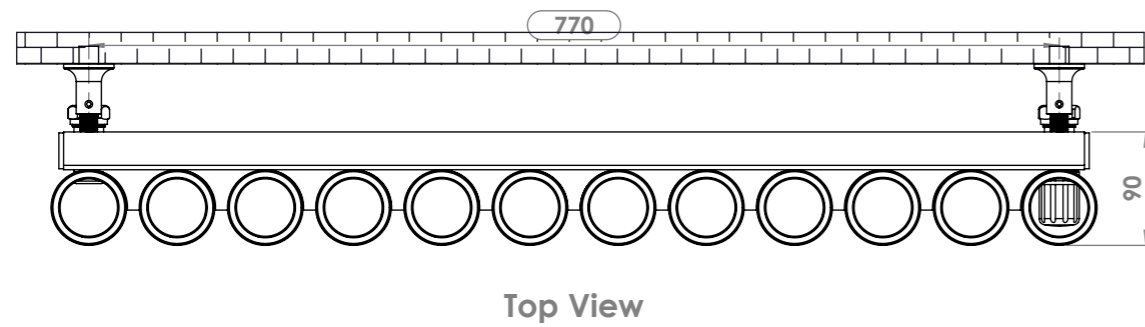
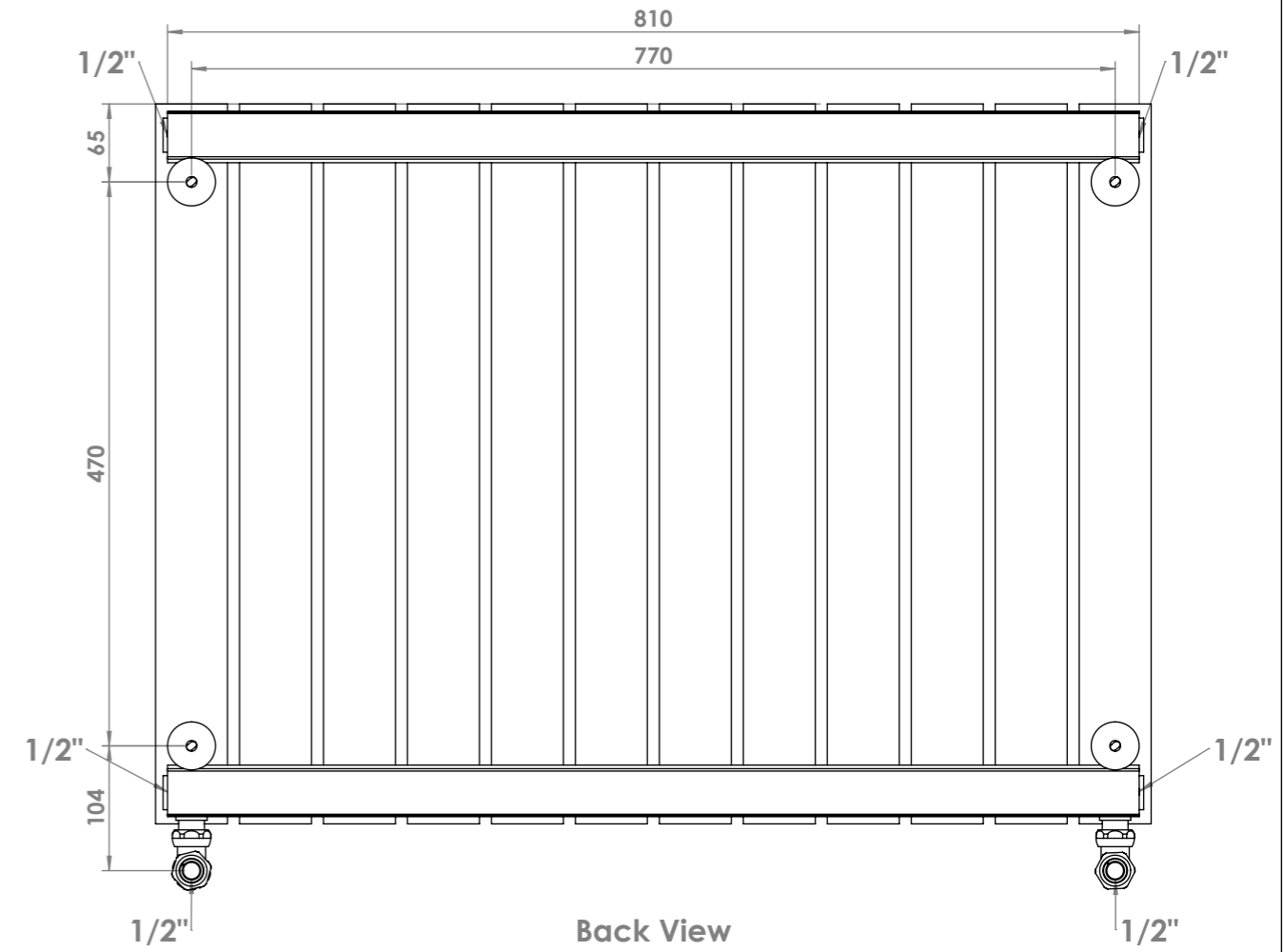
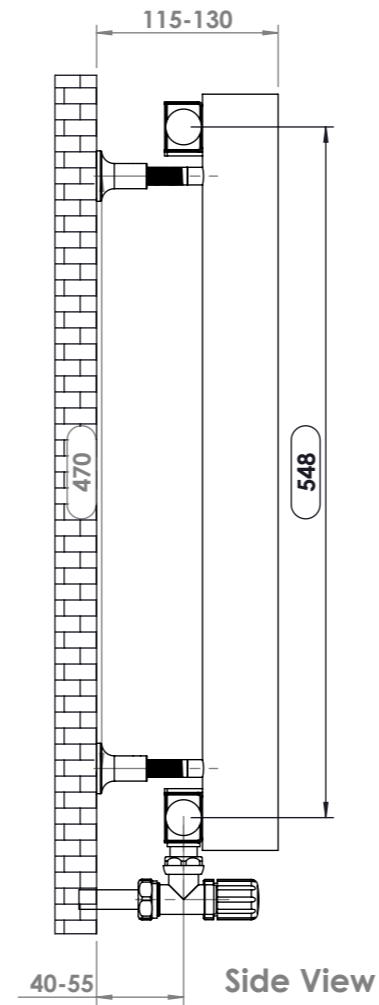
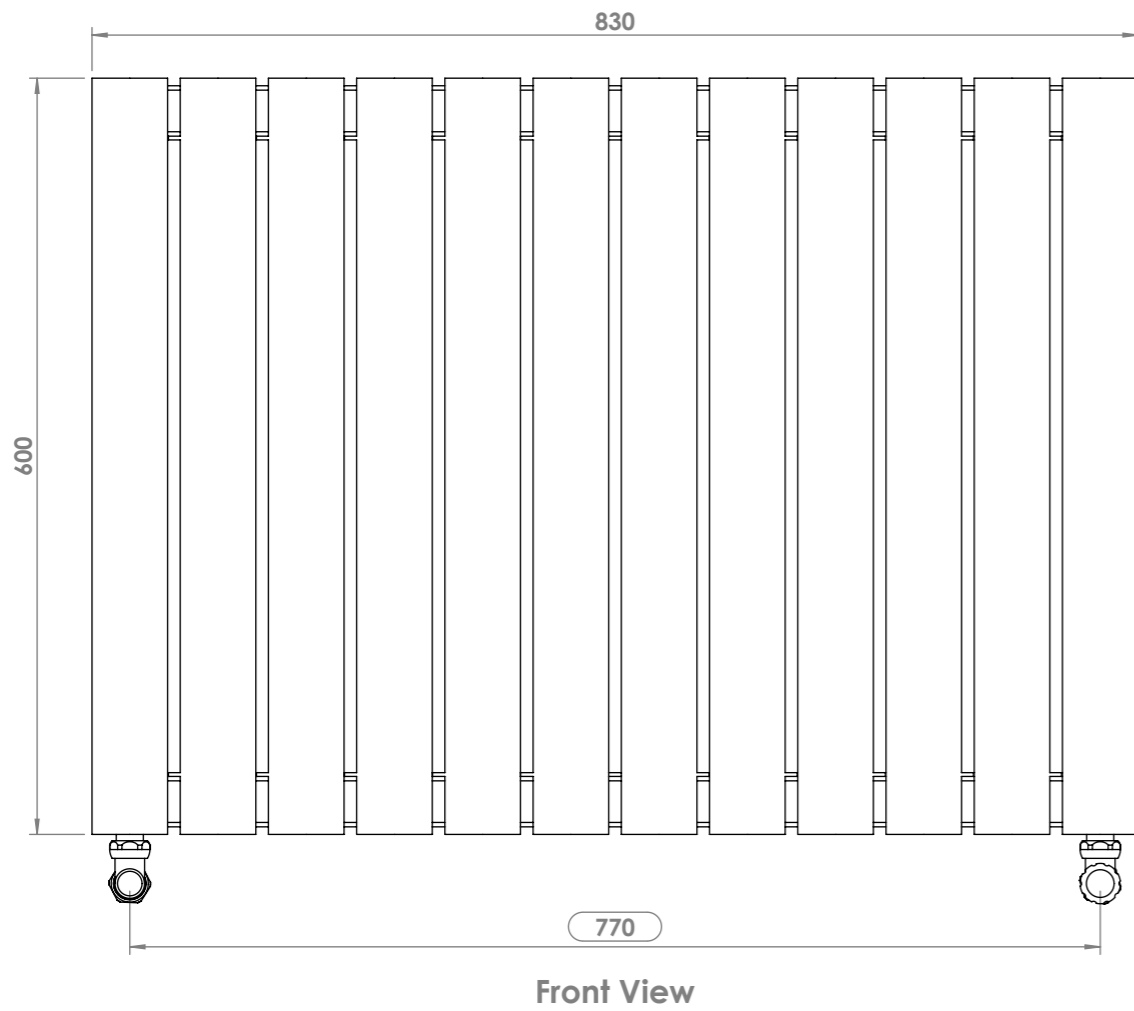

Installation Accesories:

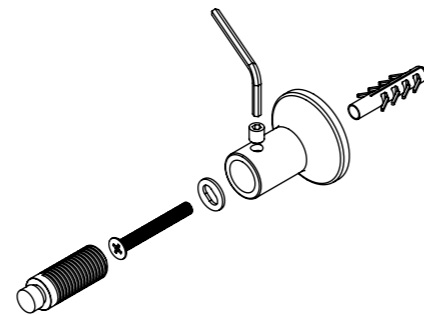
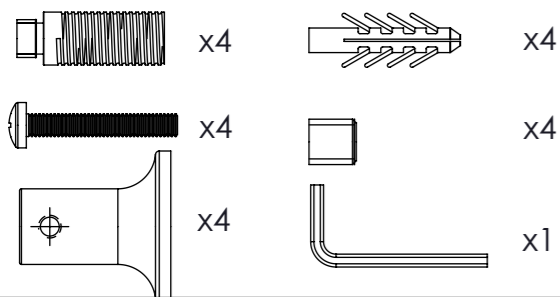

Fitting Position:

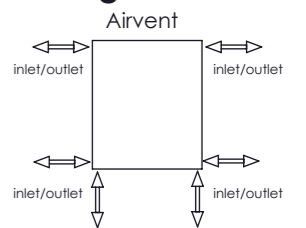

All Dimension are in mm
 Max.Working Pressure = 10 Bar
 Max.Working Temperature=95° C
 Inlet / Outlet : 1/2" BSP

A MGH=7!9.*%

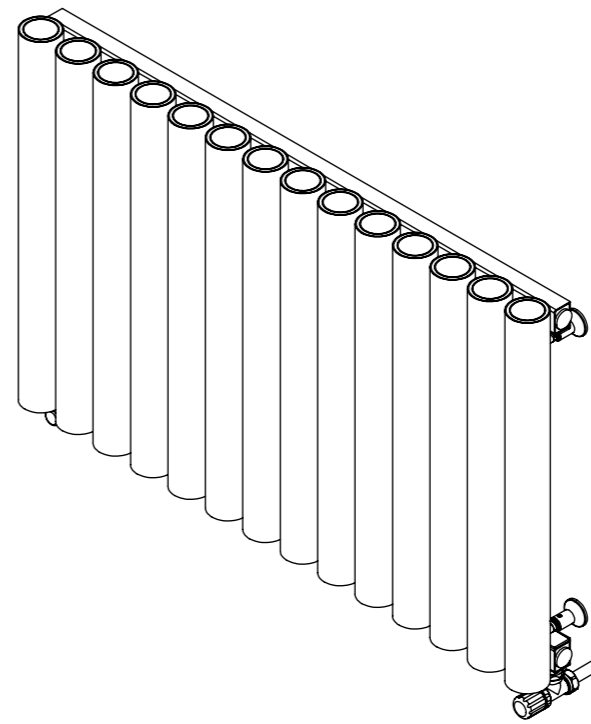
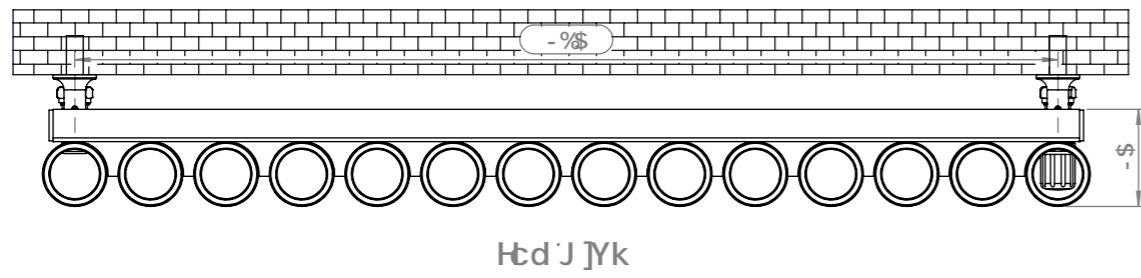
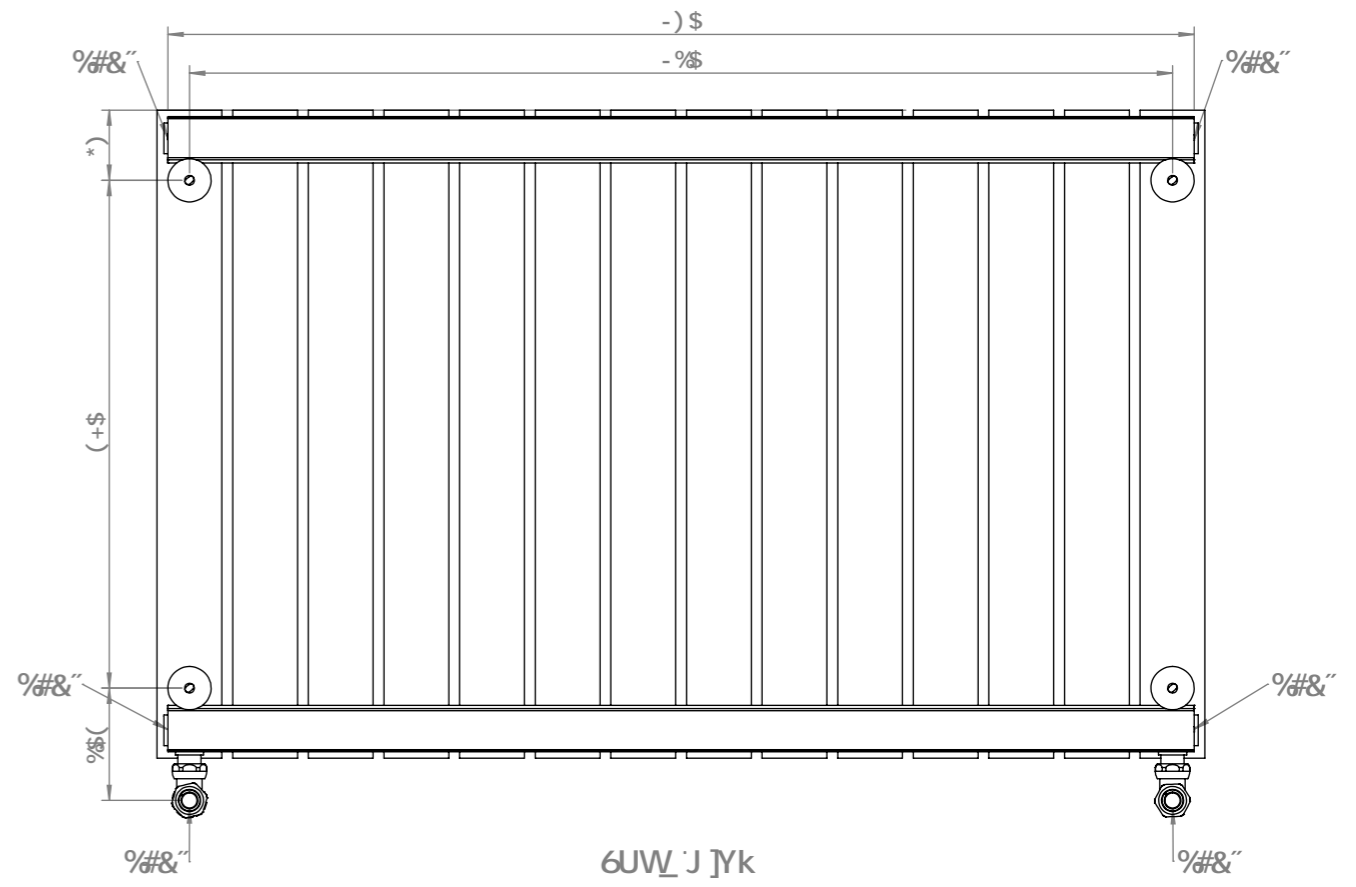
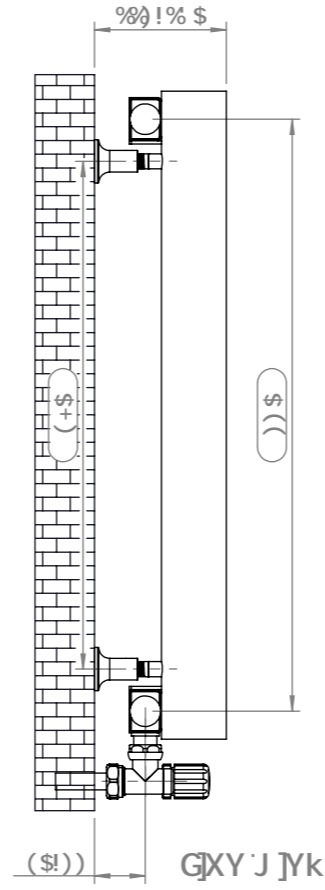
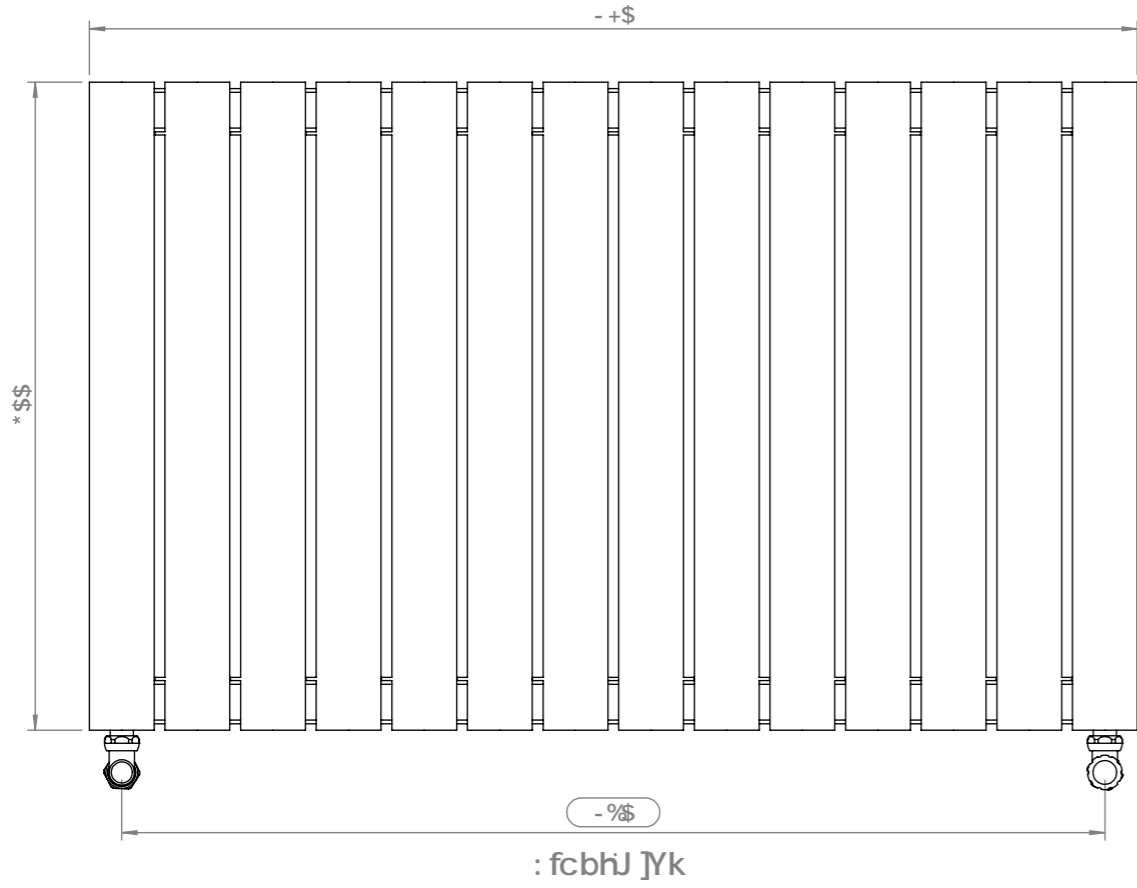

bgU`Uhcb`5WVYgc fJYg`

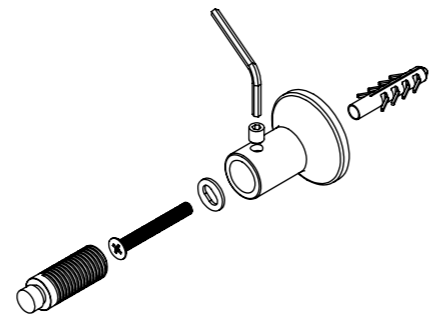
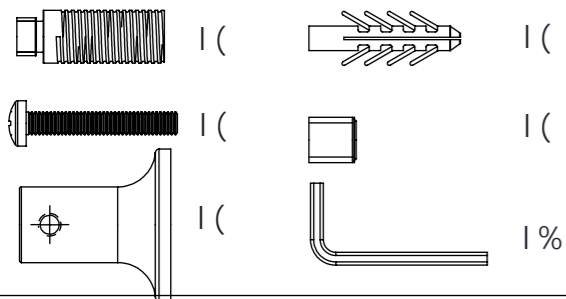

:]hb[Dcgh]cb.

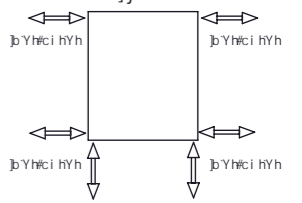

Qh/Oa ^} a } Ae^/A {
 T æÉY [\a *AU:•• ^AMFEOæ
 T æÉY [\a *A^ {] |æ j^MUJ »O
 Q| ^AU q^ AMFEOUU

A MGH=7!9.*%*

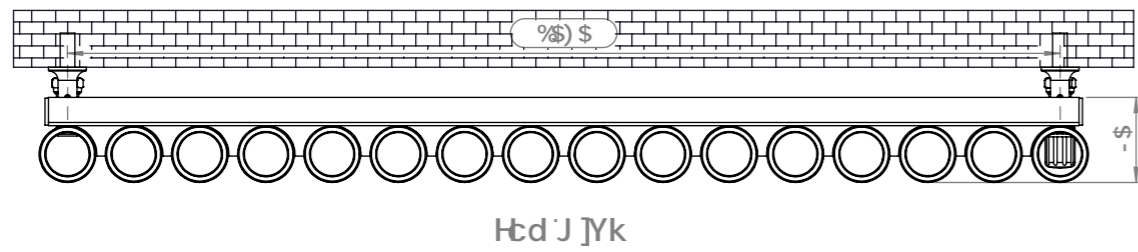
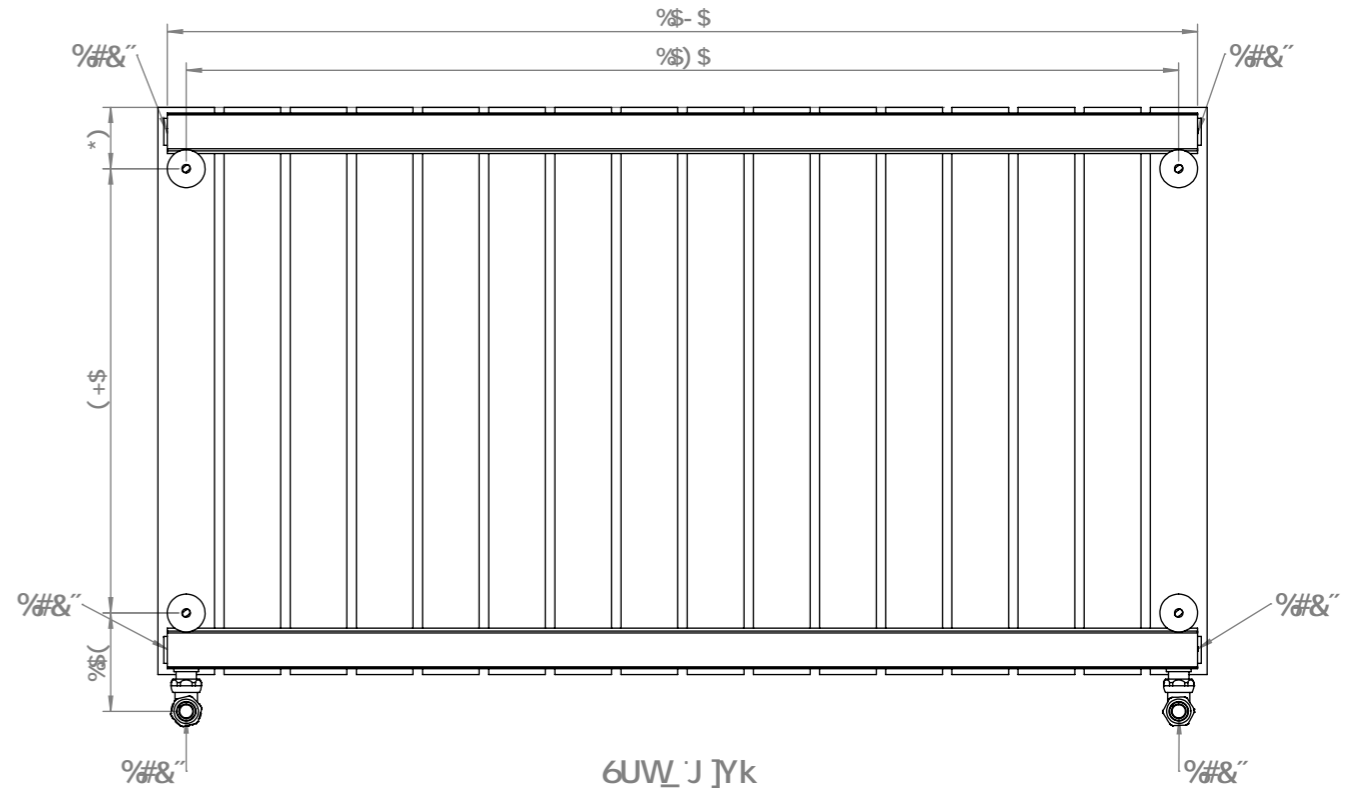
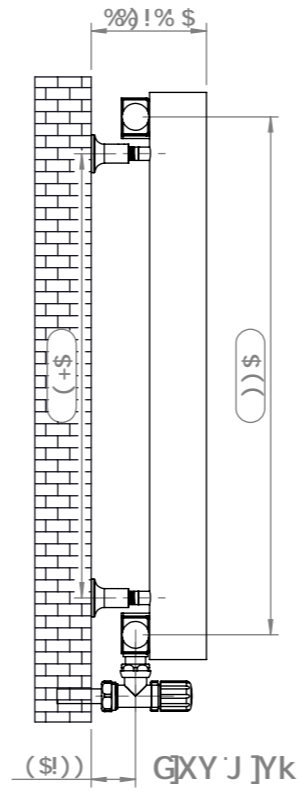
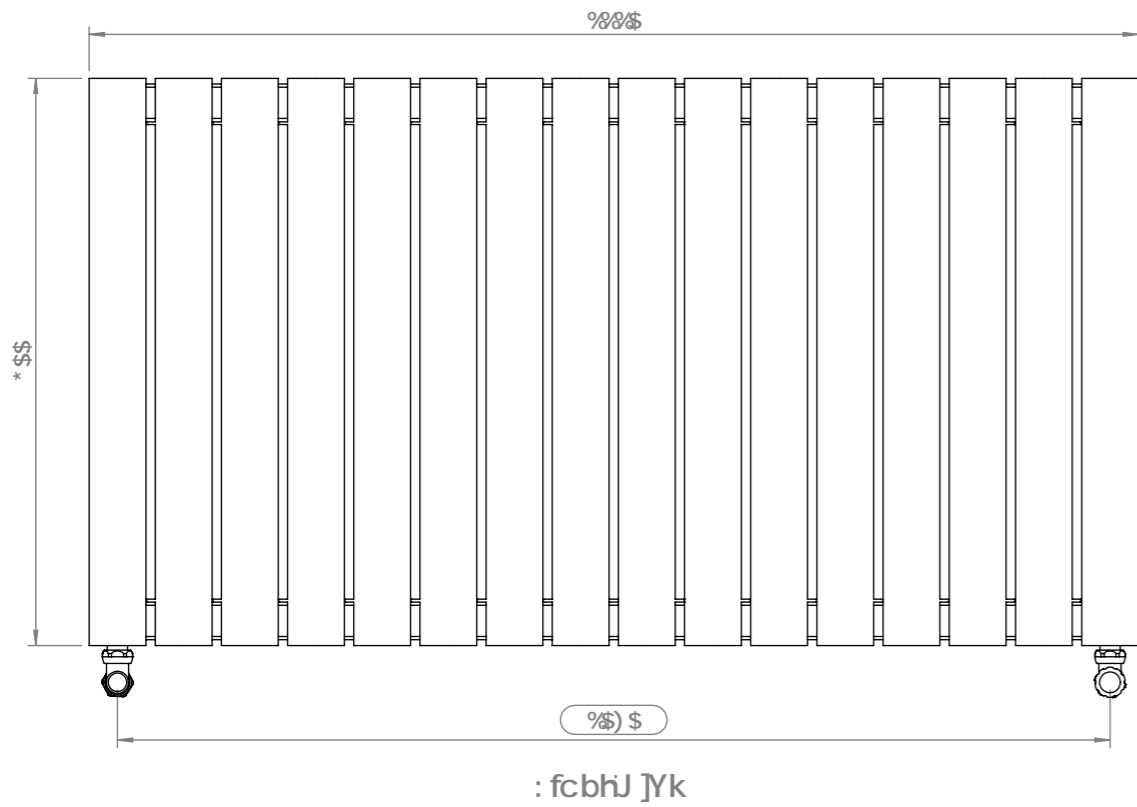

Hcd J Yk

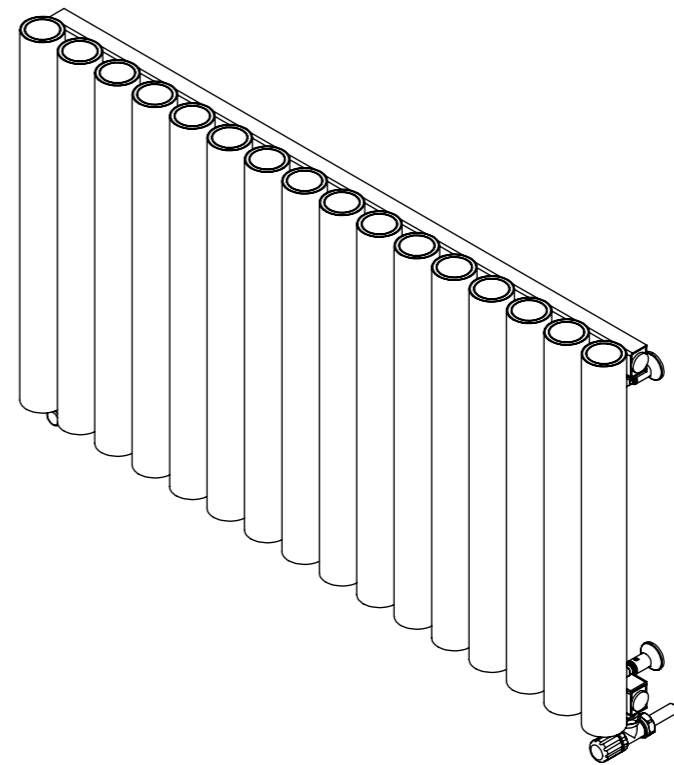

bgU`Uhcb`5WVYgc fJYg`

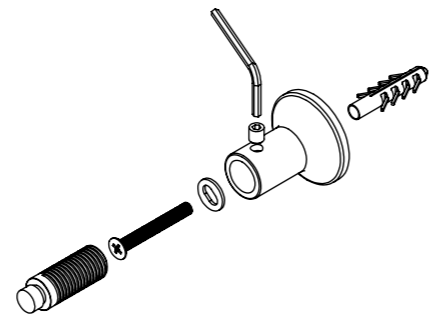
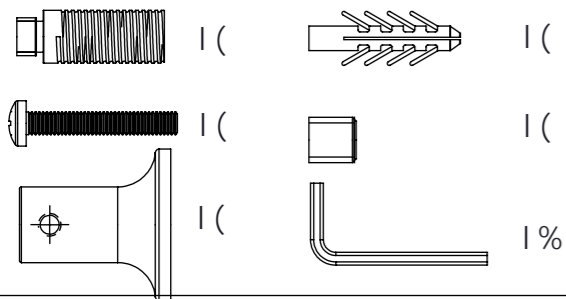

:]h[b `Dcgh]cb.

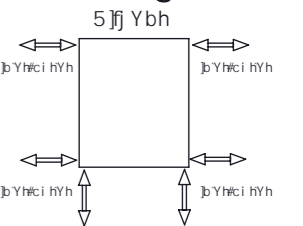

Qh/Aa ^} a } Ae^/A {
T æÉY [\a *AU!.. ^AMF€A0æ
T æÉY [\a *A^ {] |æ |^MU| »A
Q| ^AU q^ oMFEAYOUU