

DUBUYU'6UH %+\$('

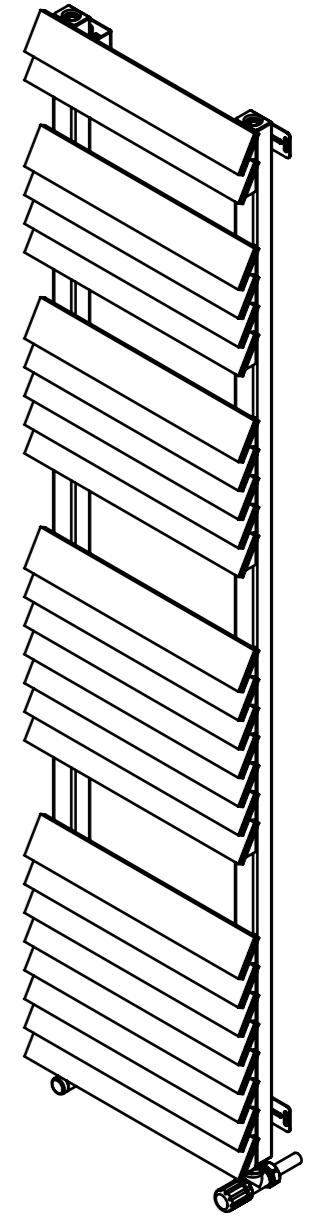

fbgU~UH'cb '5VWVggcfJYg'

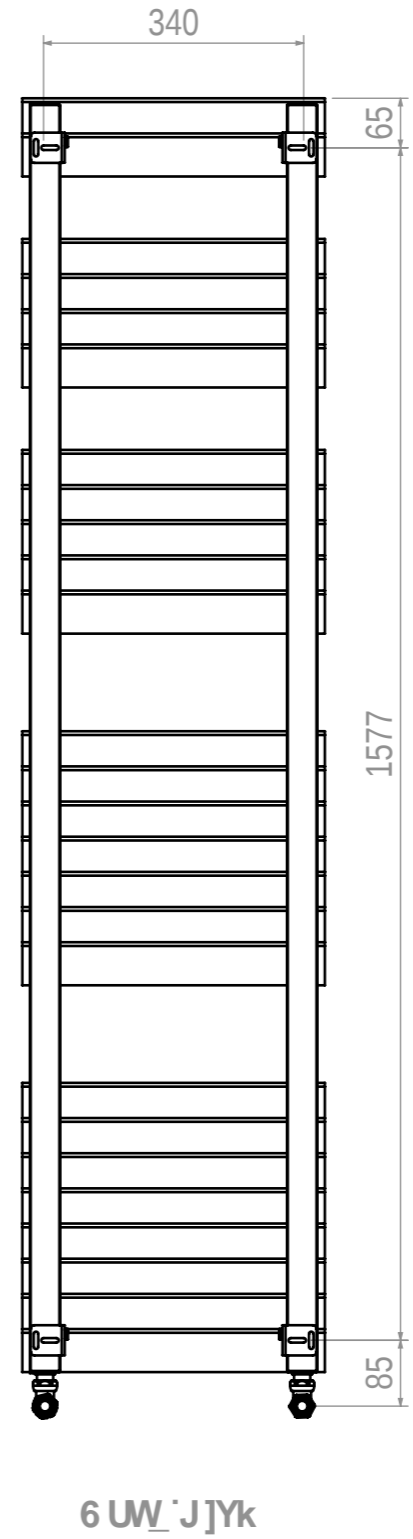
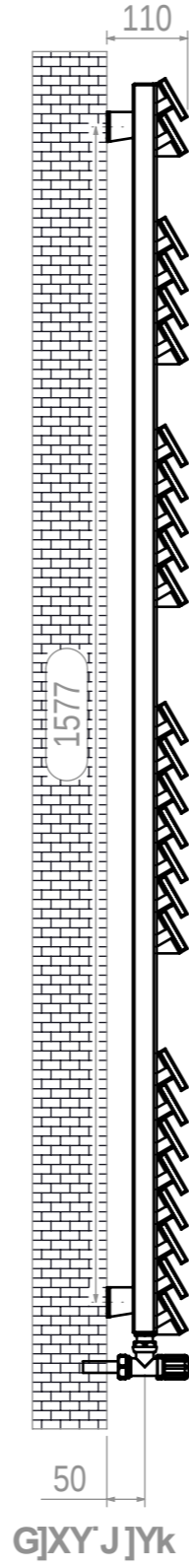
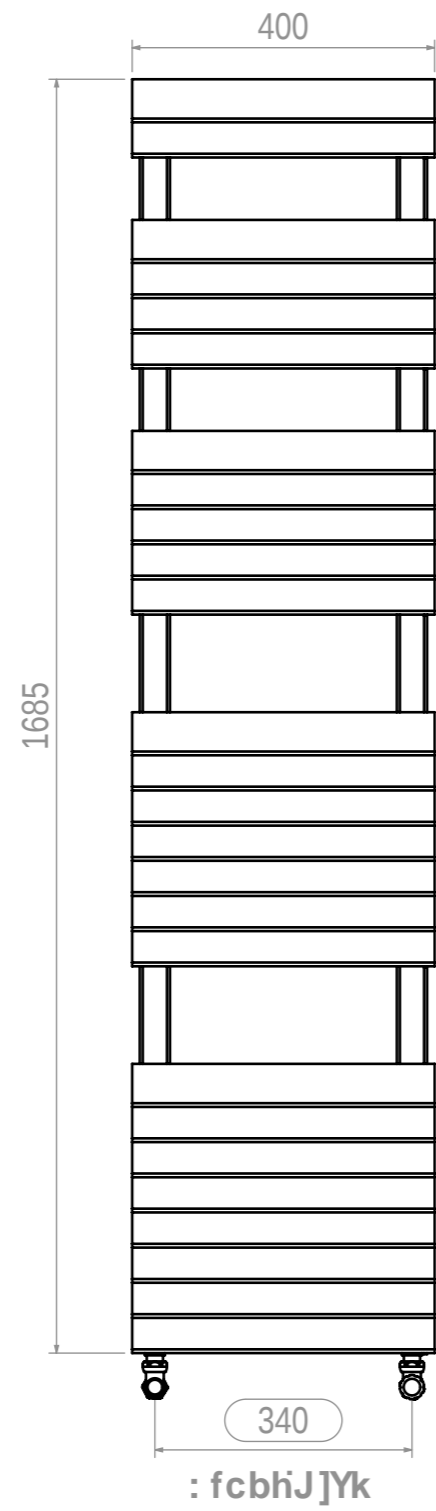
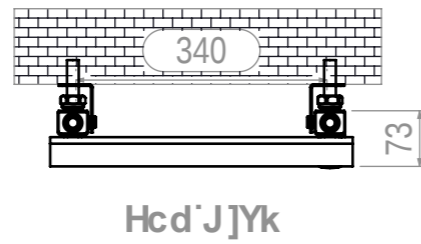
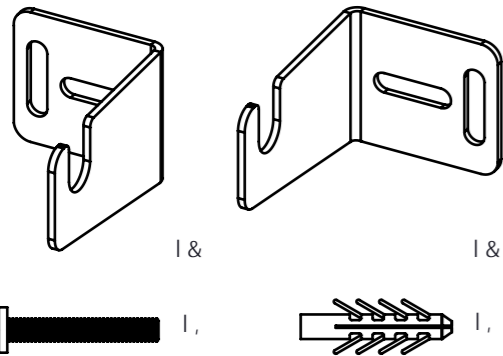

'Di a V]b['Dcg]h'cb.'

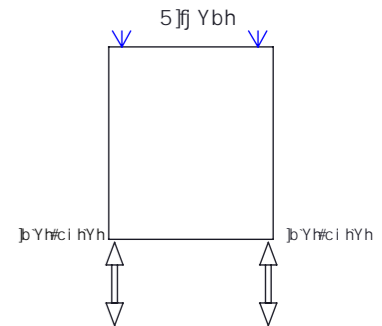

X^|_caA [' } c
 CE|AOa ^) . a } . Ae^/a A {
 T aeEY [| \ a * AU^.. ^ ^hA AOae
 T aeEY [| \ a * A/\ [] ^ ae | ^hU | »AO
 QJ^cAU' c^a^AFBAYOUU
 Ø ^|AOEP DO