

SERHAD 100-60

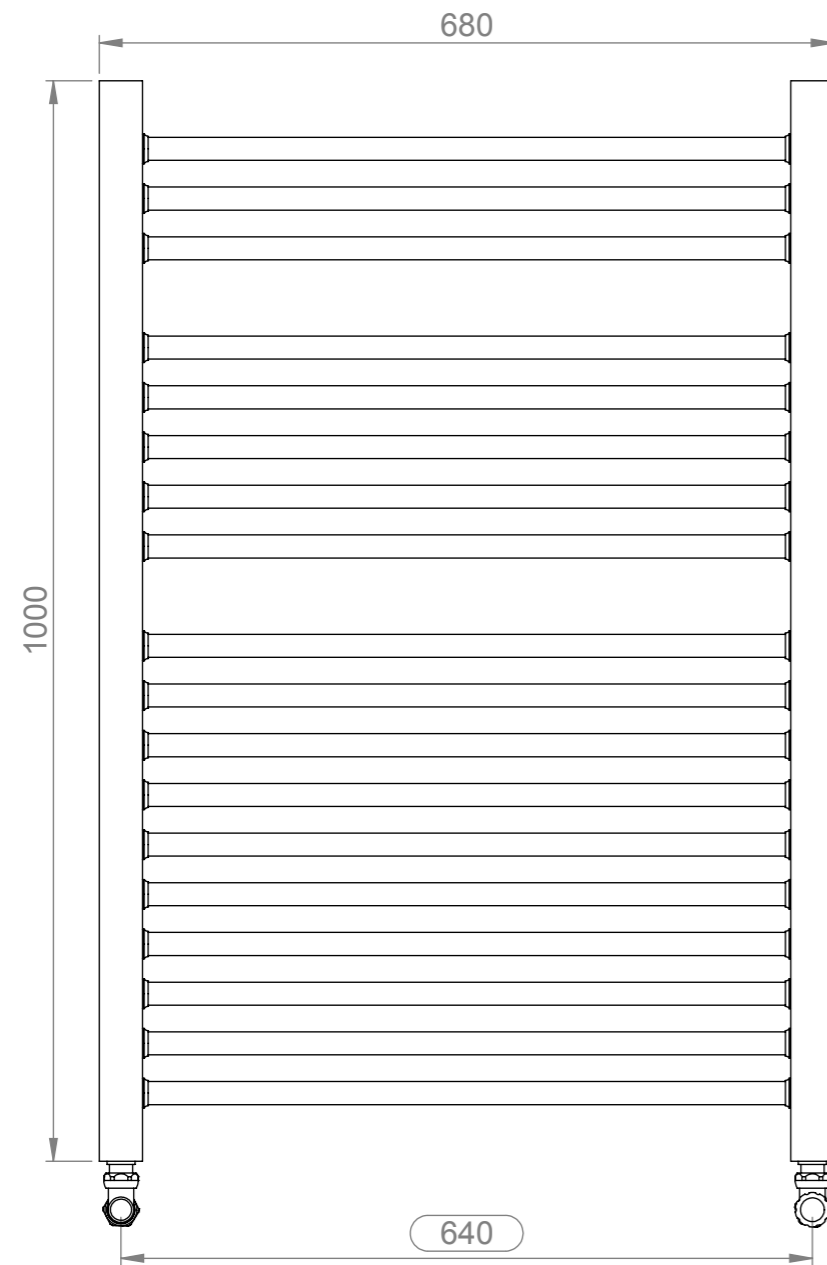

Front View

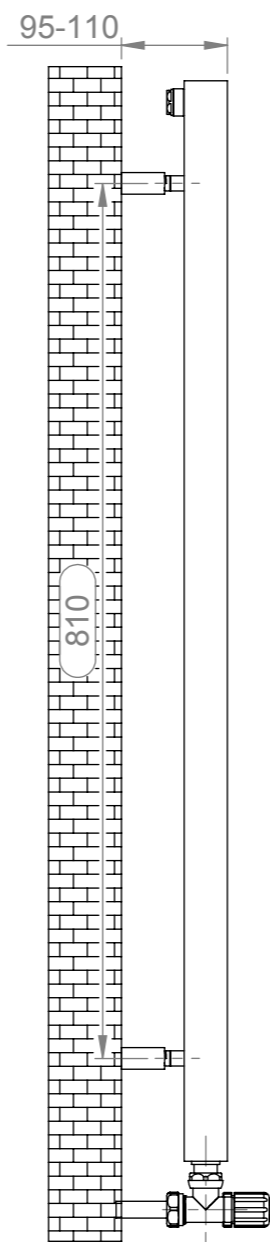

Side View

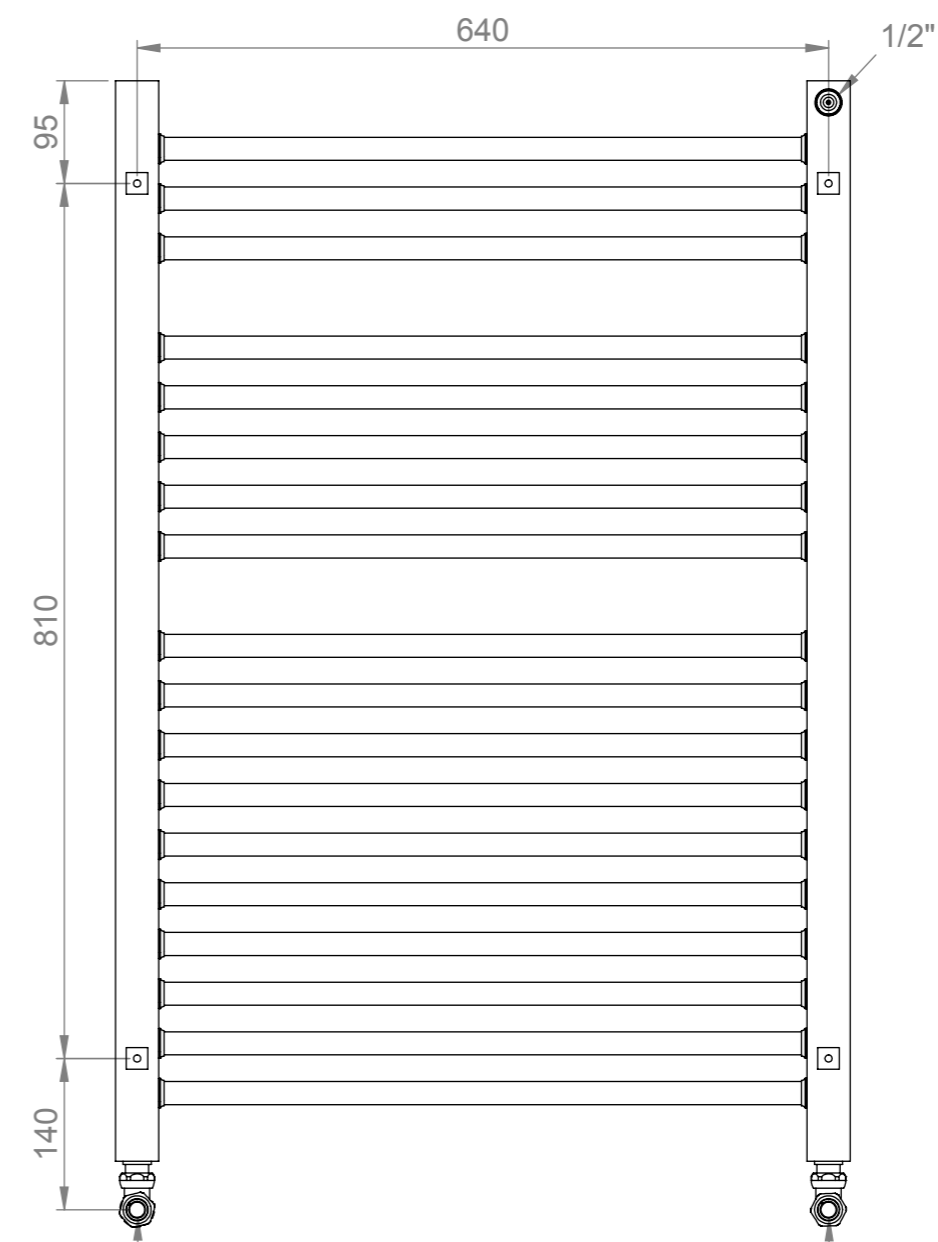



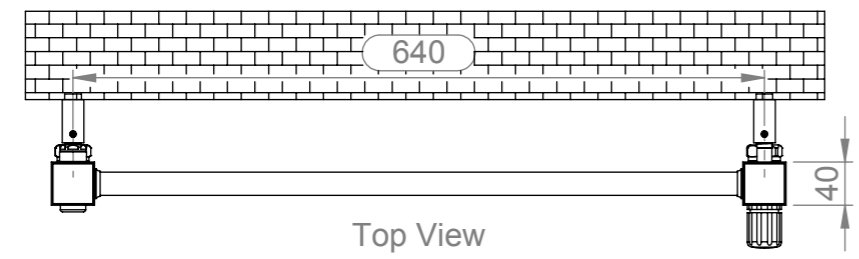
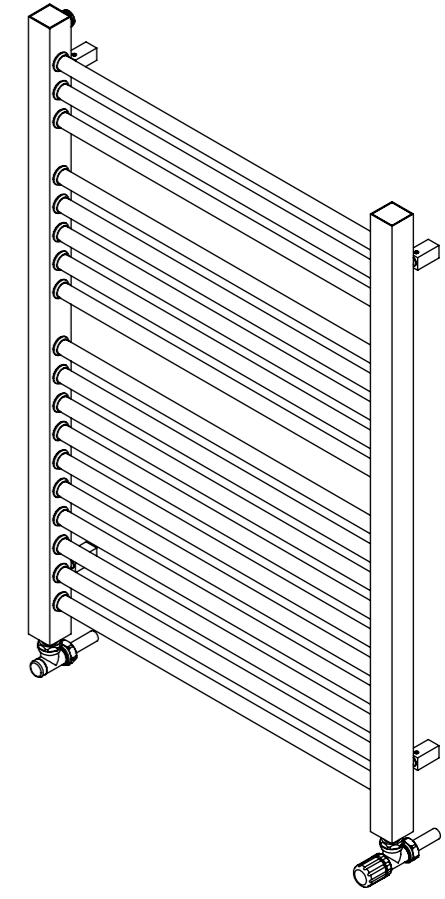

Back View

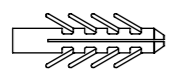

Top View

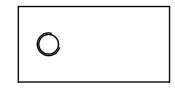
Installation Accesories:

-  x4
-  x4
-  x4
-  x4
-  x4
-  x1

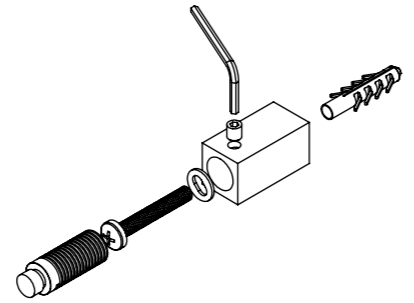

Fitting Position:

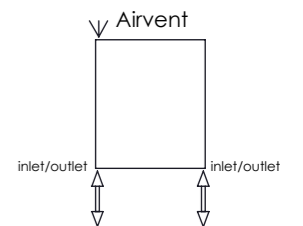

All Dimension are in mm
 Max. Working Pressure = 10 Bar
 Max. Working Temperature = 95° C
 Inlet / Outlet : 1/2" BSP