

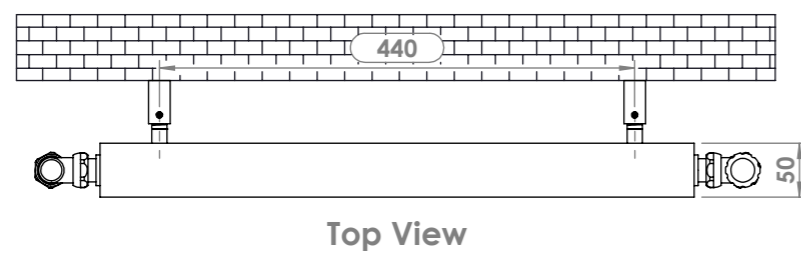

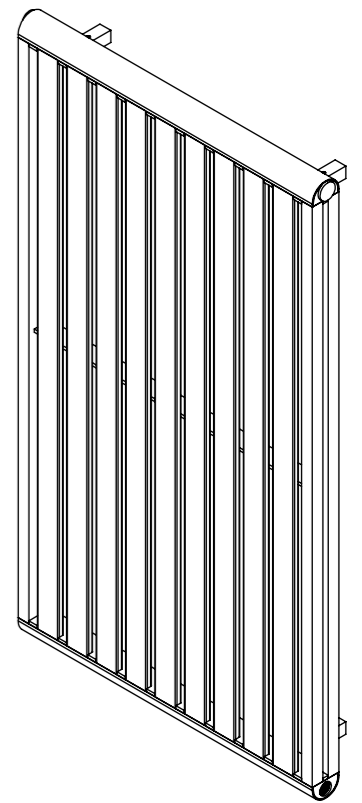

Supra D 105

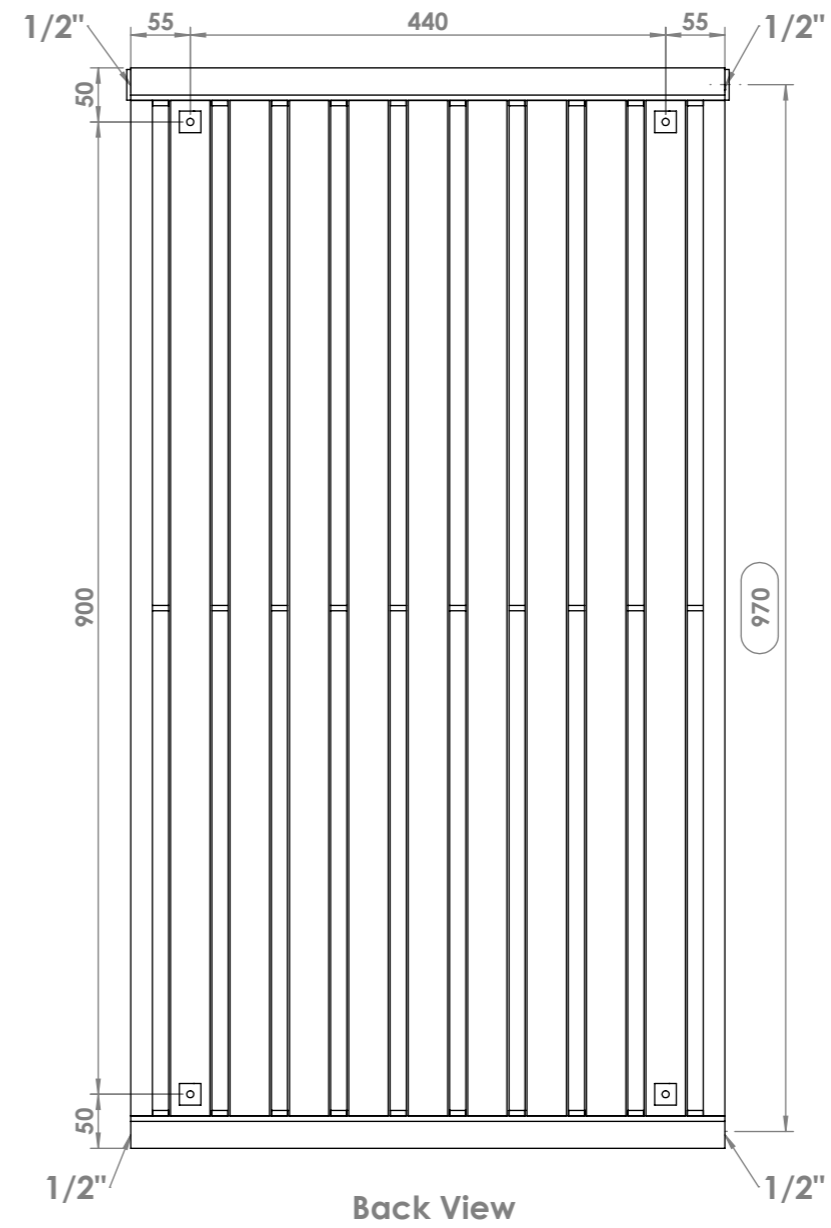
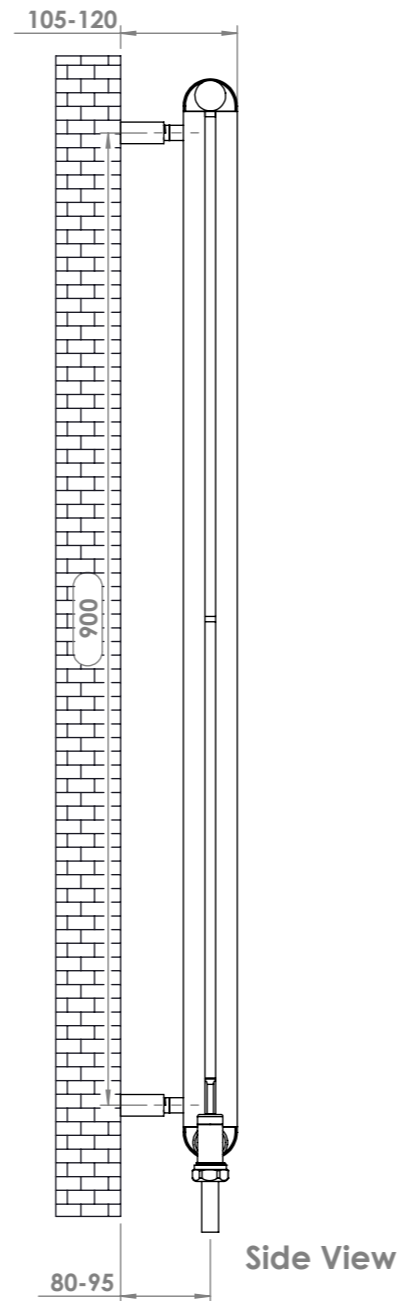
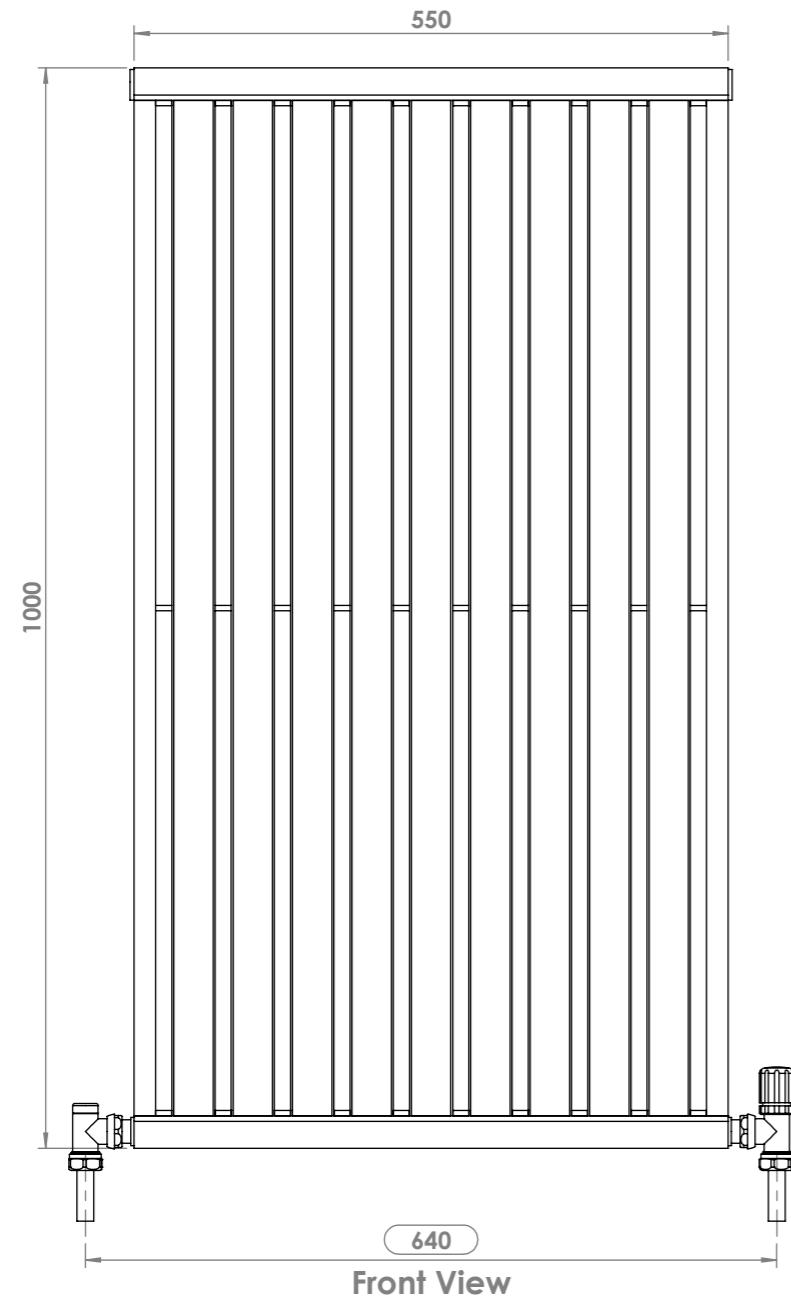
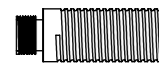
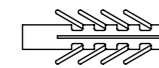

Installation Accesories:

-  x4
-  x4
-  x4
-  x4
-  x4
-  x1

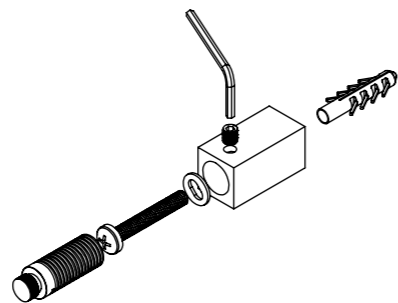

Fitting Position:

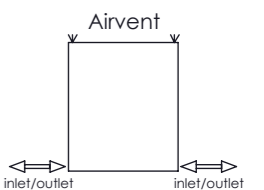

All Dimension are in mm
 Max.Working Pressure = 10 Bar
 Max.Working Temperature=95° C
 Inlet / Outlet : 1/2" BSP