

# TR01750

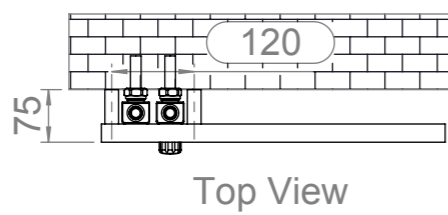

## Installation Accesories:

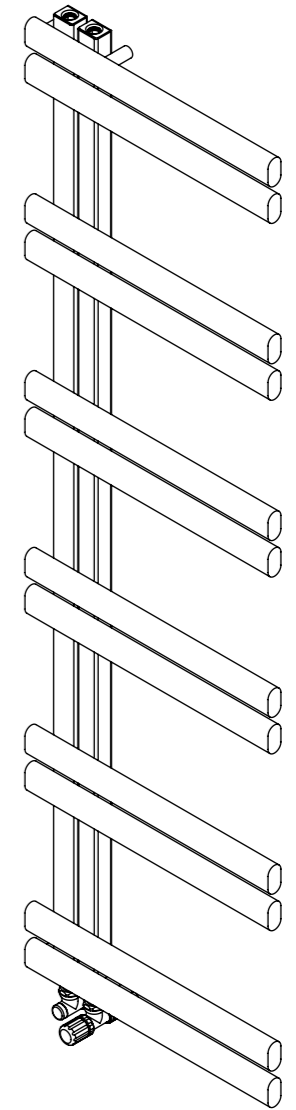
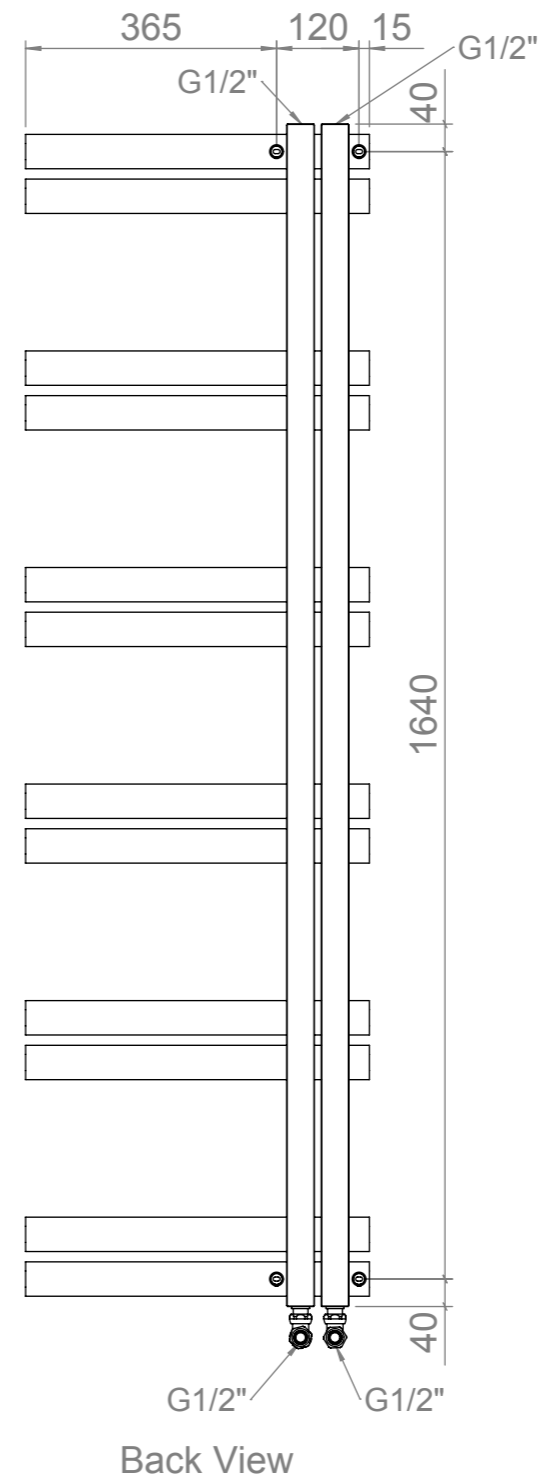
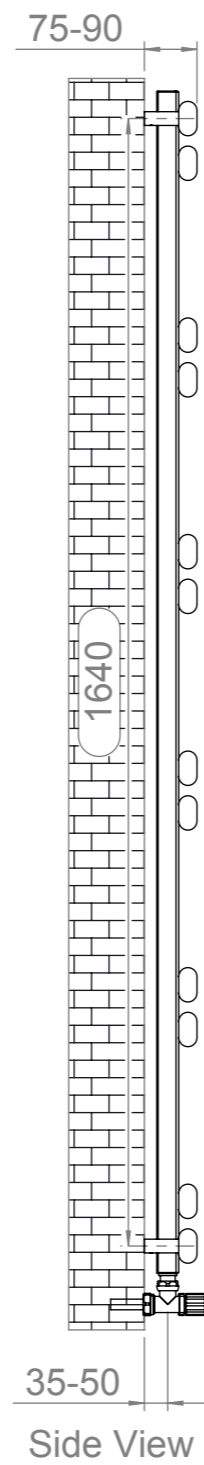
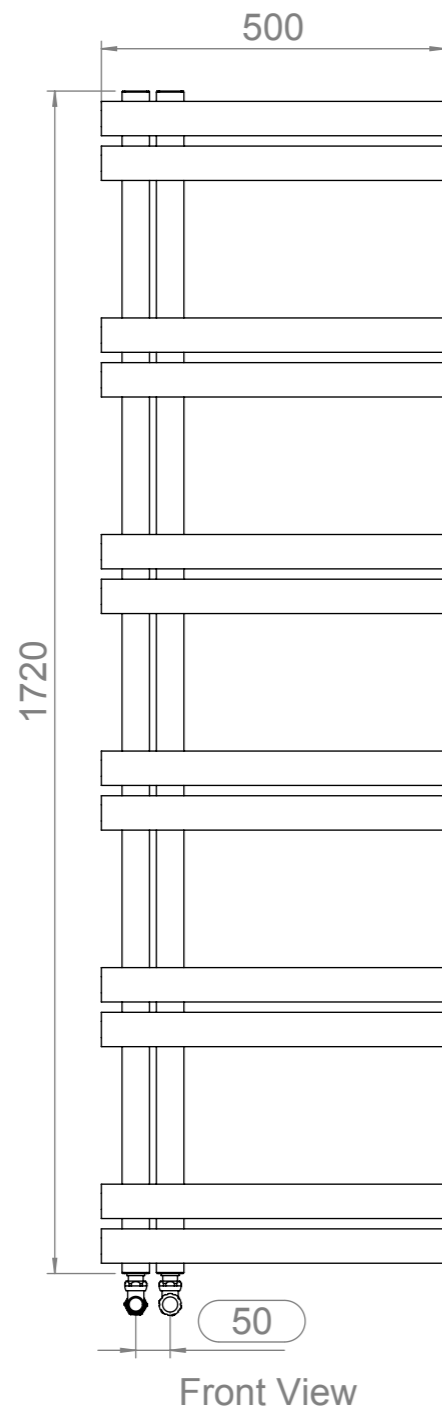
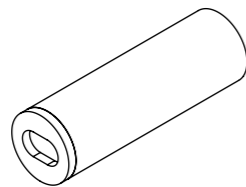
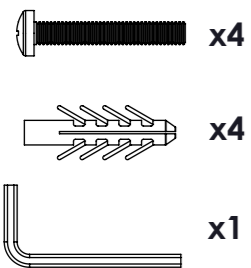

## Fitting Position:

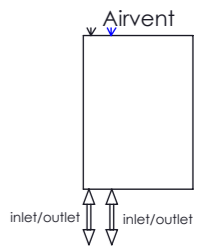

Vertical Mount  
 All Dimension are in mm  
 Max.Working Pressure = 10 Bar  
 Max.Working Temperature=95° C  
 Inlet / Outlet : 1/2" BSP  
 Fuel: H