

TR0850

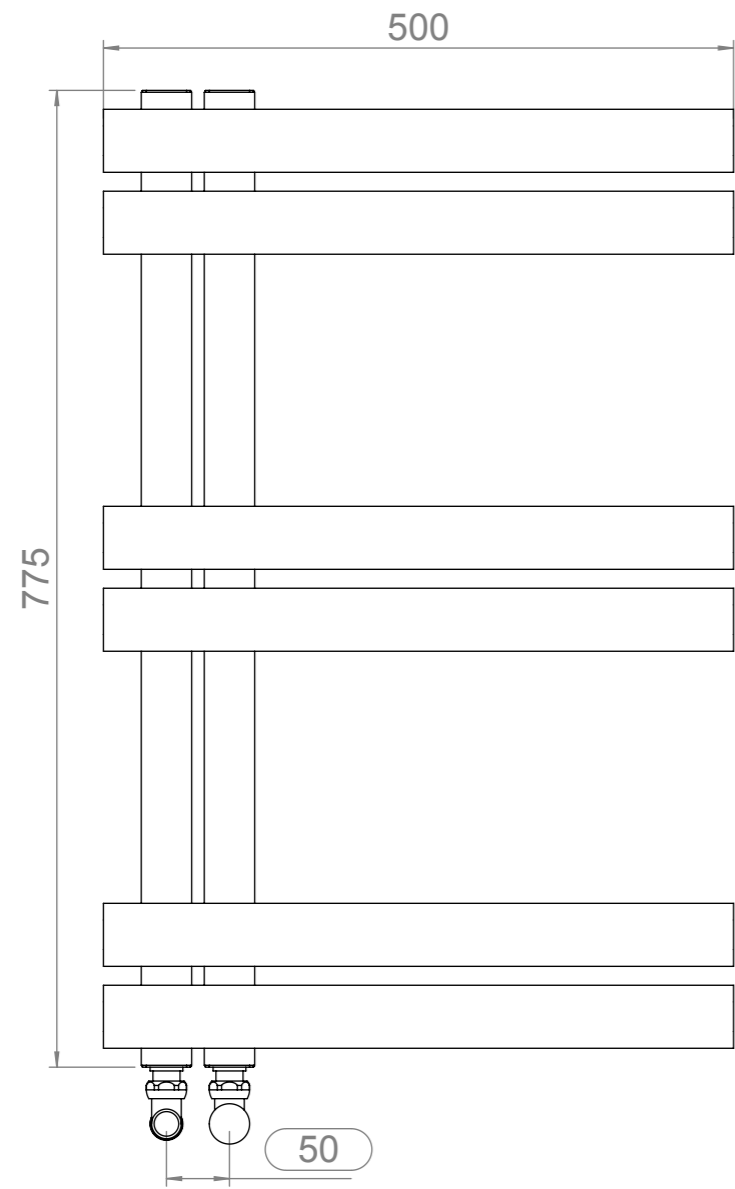

Front View

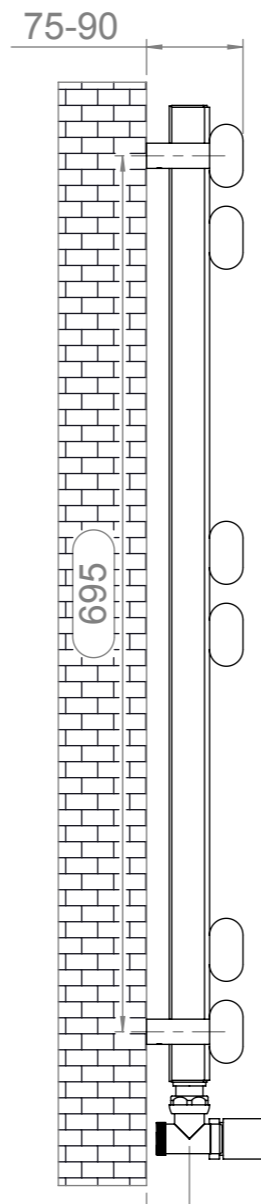

Side View

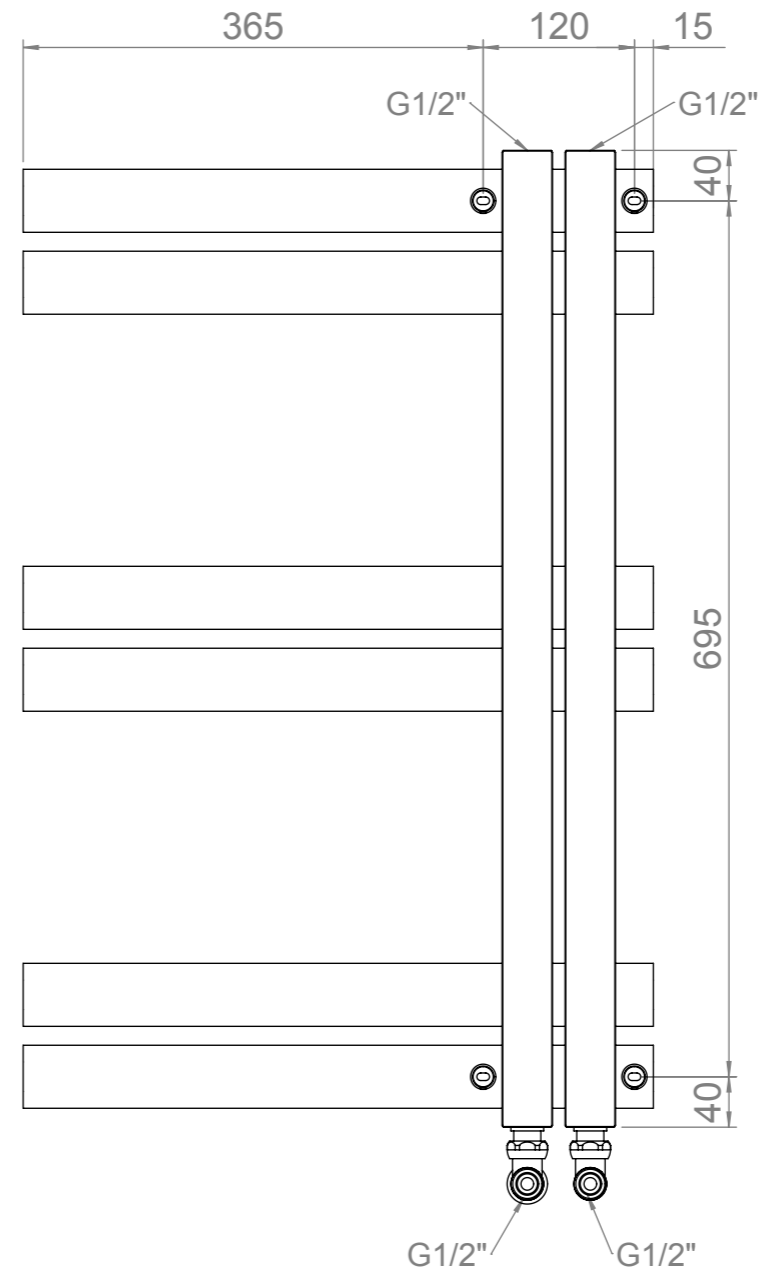

Back View

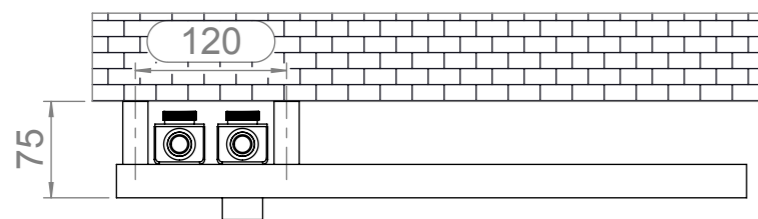

Top View

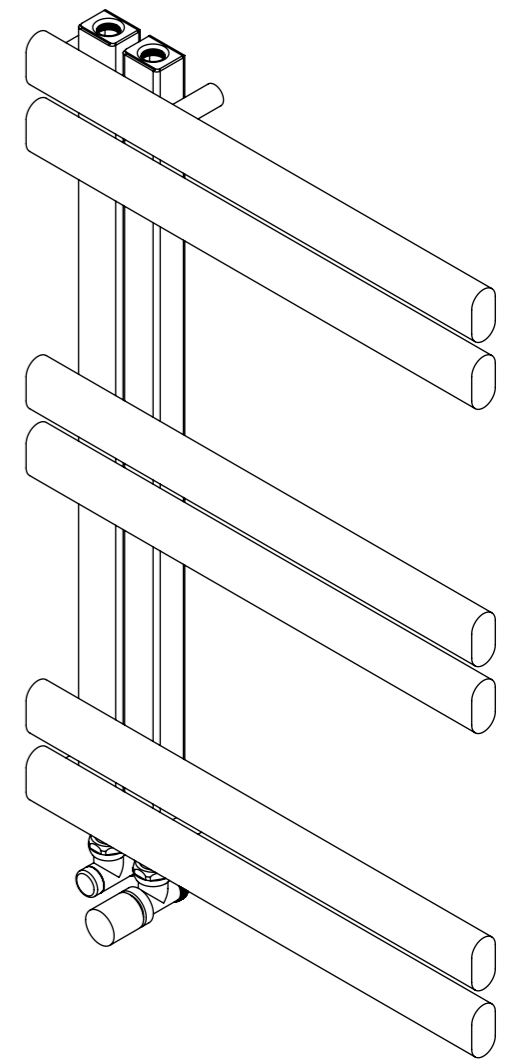

Installation Accesories:

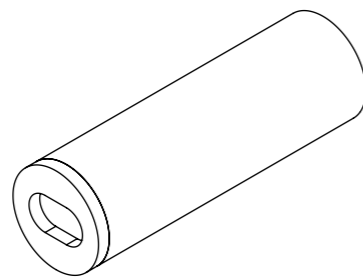

Fitting Position:

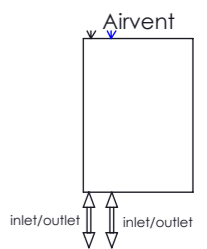

Vertical Mount
 All Dimension are in mm
 Max.Working Pressure = 10 Bar
 Max.Working Temperature=95° C
 Inlet / Outlet : 1/2" BSP
 Fuel: H