

# Tudor 512 Rev01

REVISIONS				
ZONE	REV.	DESCRIPTION	DATE	APPROVED
	00	İlk Yayın Tarihi	01.01.2011	ONAYLAYAN
	01	Tudor boru bağlantı kafa pulu iptal edildi. Boru Ø40x1,5mm iptal edildi. Yerine Ø42,4x1,5mm boru kullanıldı.	29.07.2020	H.KÖROĞLU

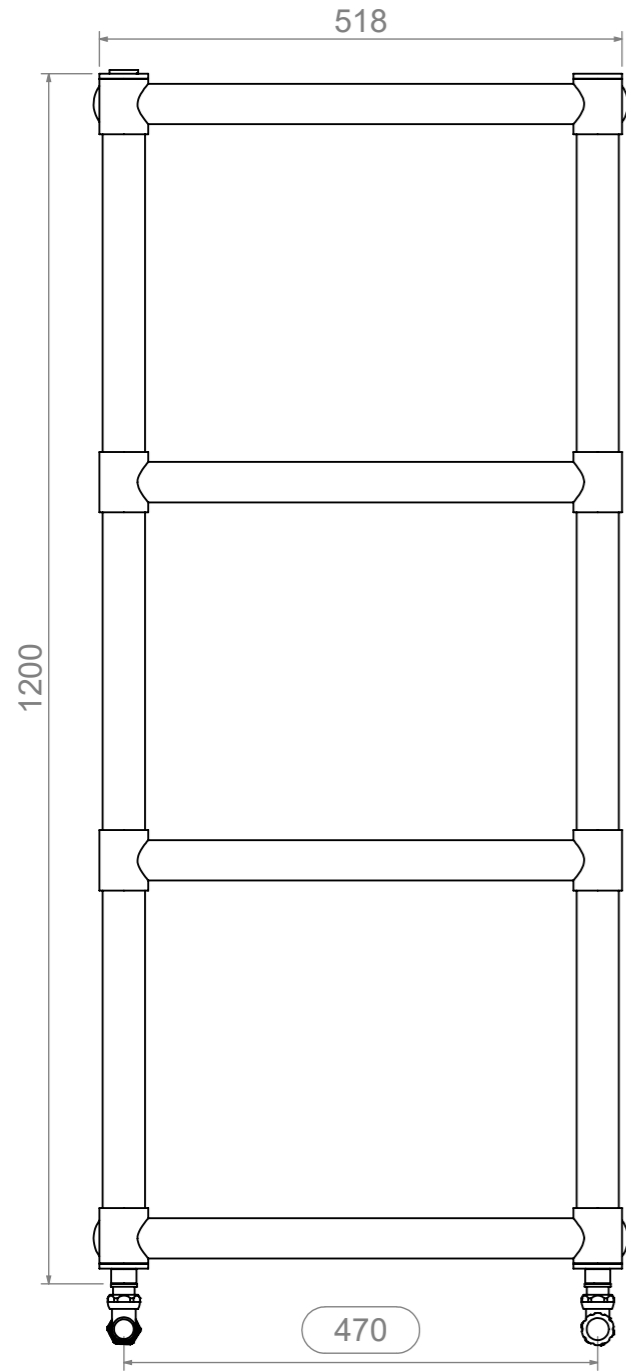

Front View

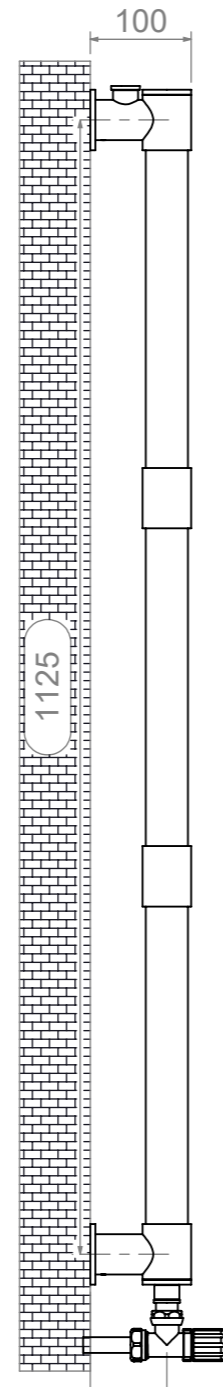

Side View

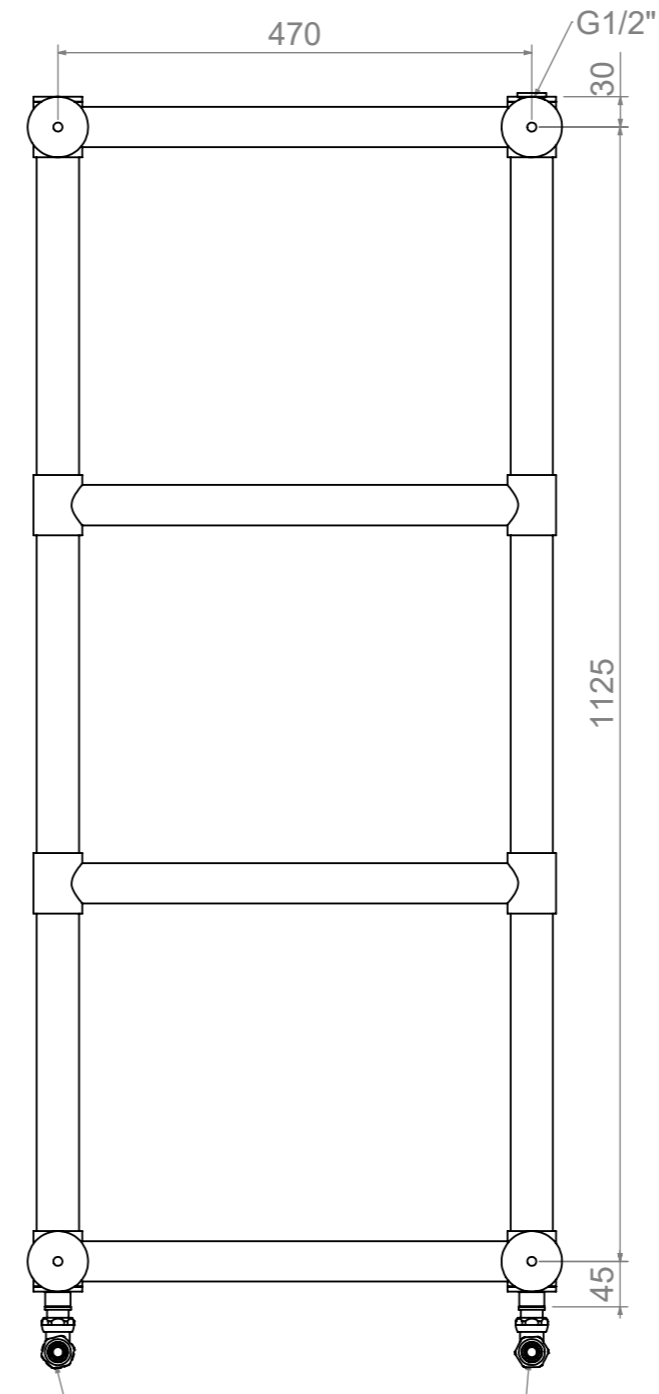

Back View

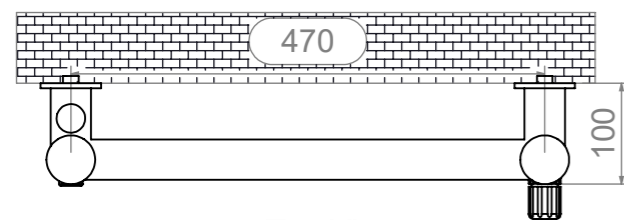
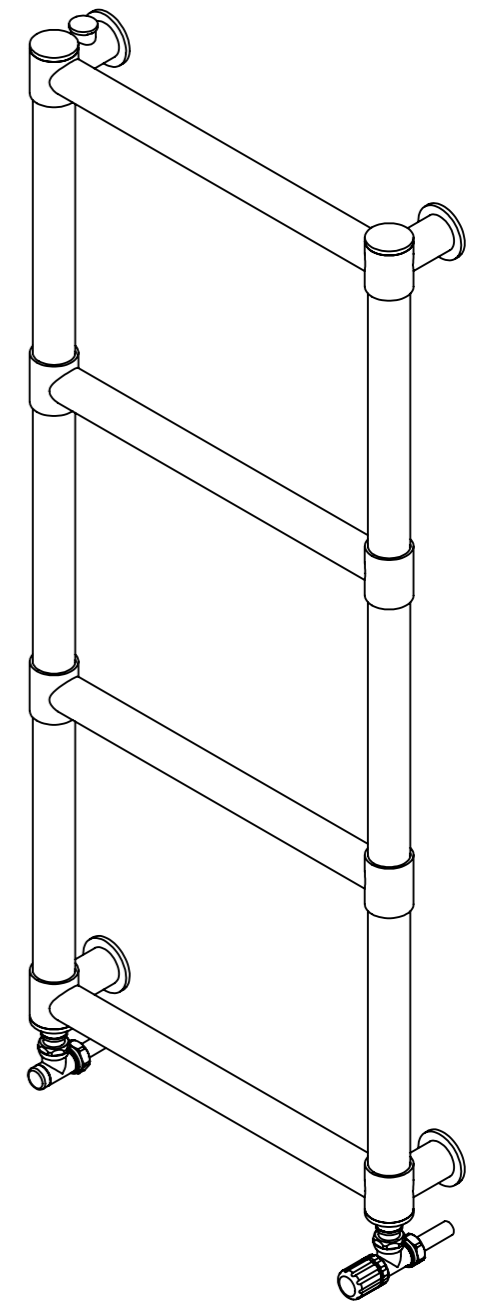

Top View

### Fitting Position:

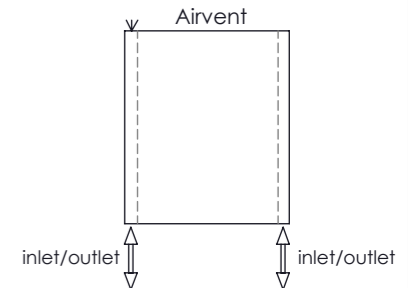

### Installation Accessories:

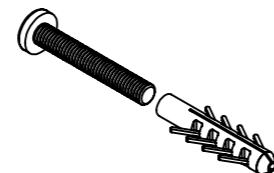

All Dimension are in mm  
 Max.Working Pressure = 10 Bar  
 Max.Working Temperature=95° C  
 Inlet / Outlet : 1/2" BSP