

Tudor 612 Rev01

REVISIONS				
ZONE	REV.	DESCRIPTION	DATE	APPROVED
	00	İlk Yayın Tarihi	01.01.2011	ONAYLAYAN
	01	Tudor boru bağlantı kafa pulu iptal edildi. Boru Ø40x1,5mm iptal edildi. Yerine Ø42,4x1,5mm boru kullanıldı.	29.07.2020	H.KÖROĞLU

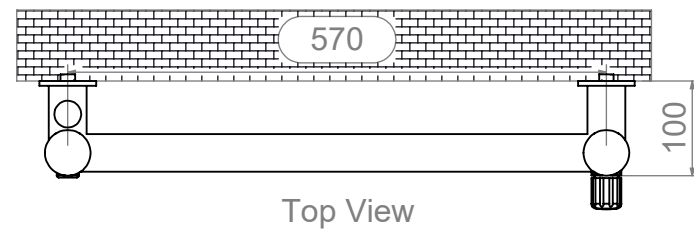

Fitting Position:

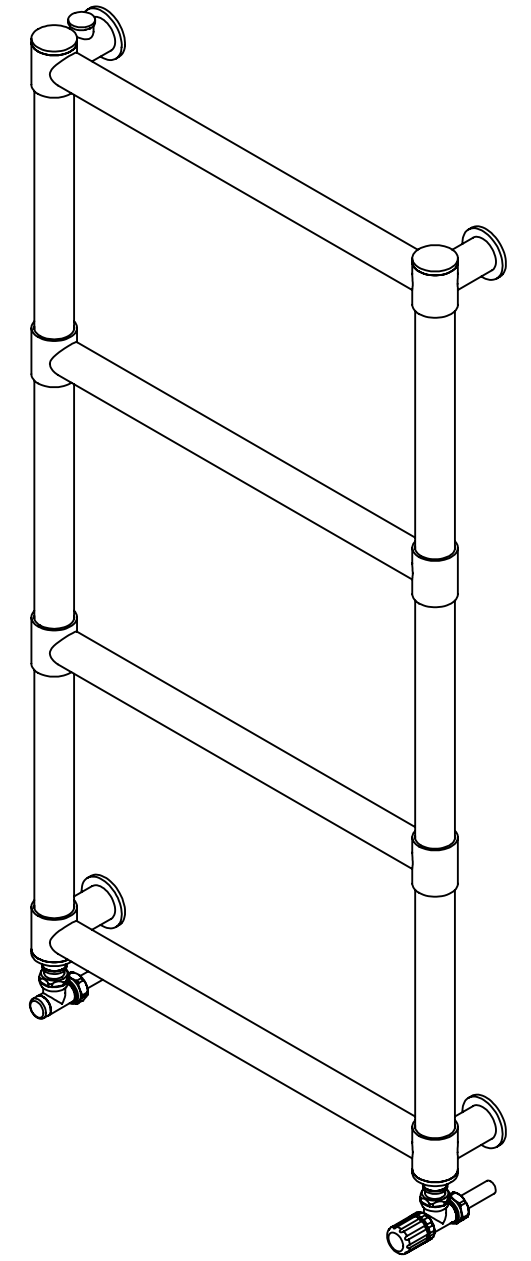
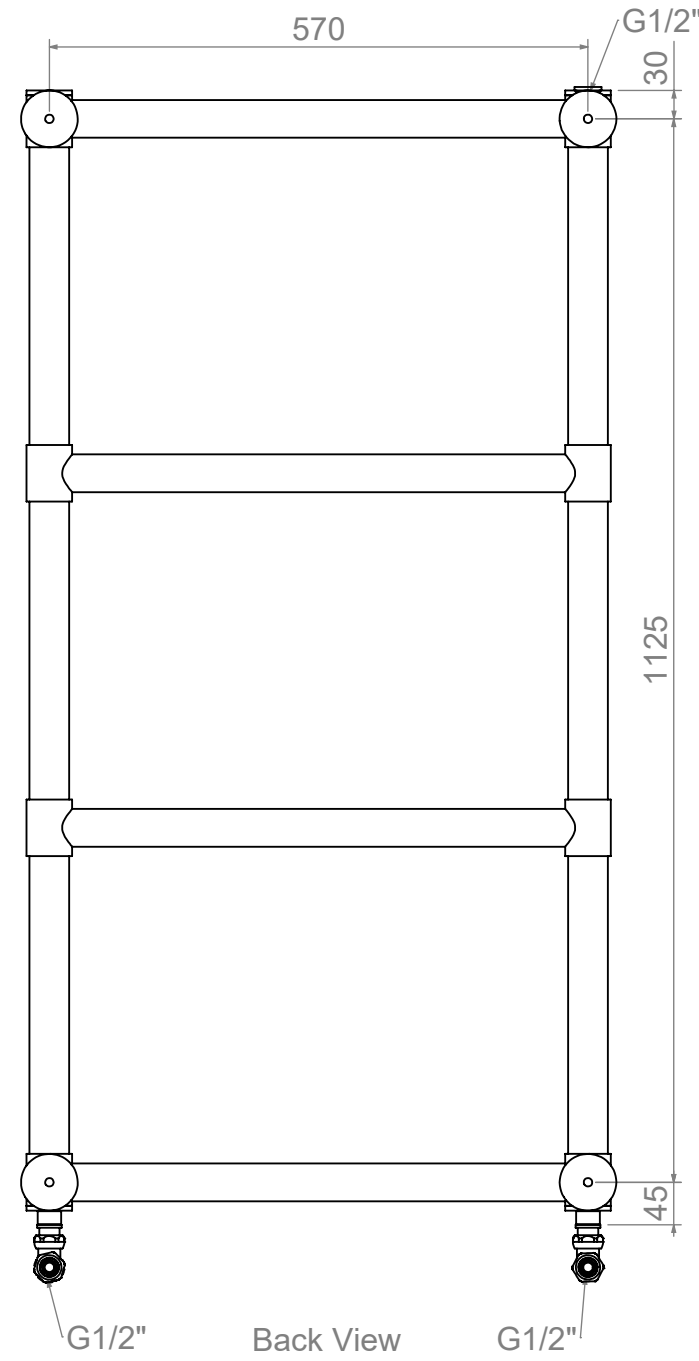
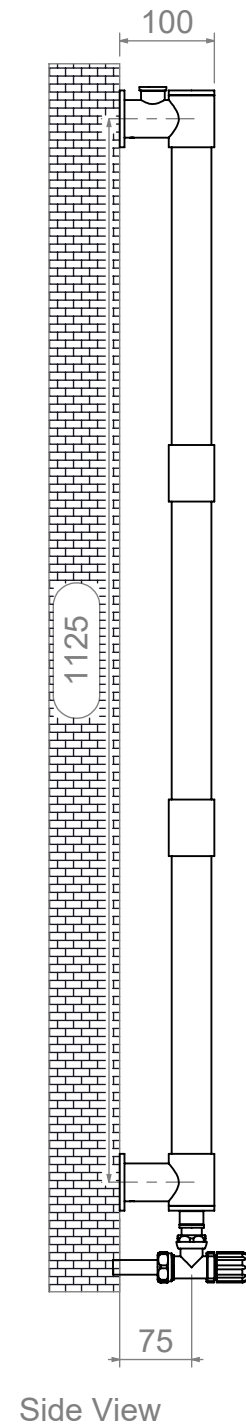
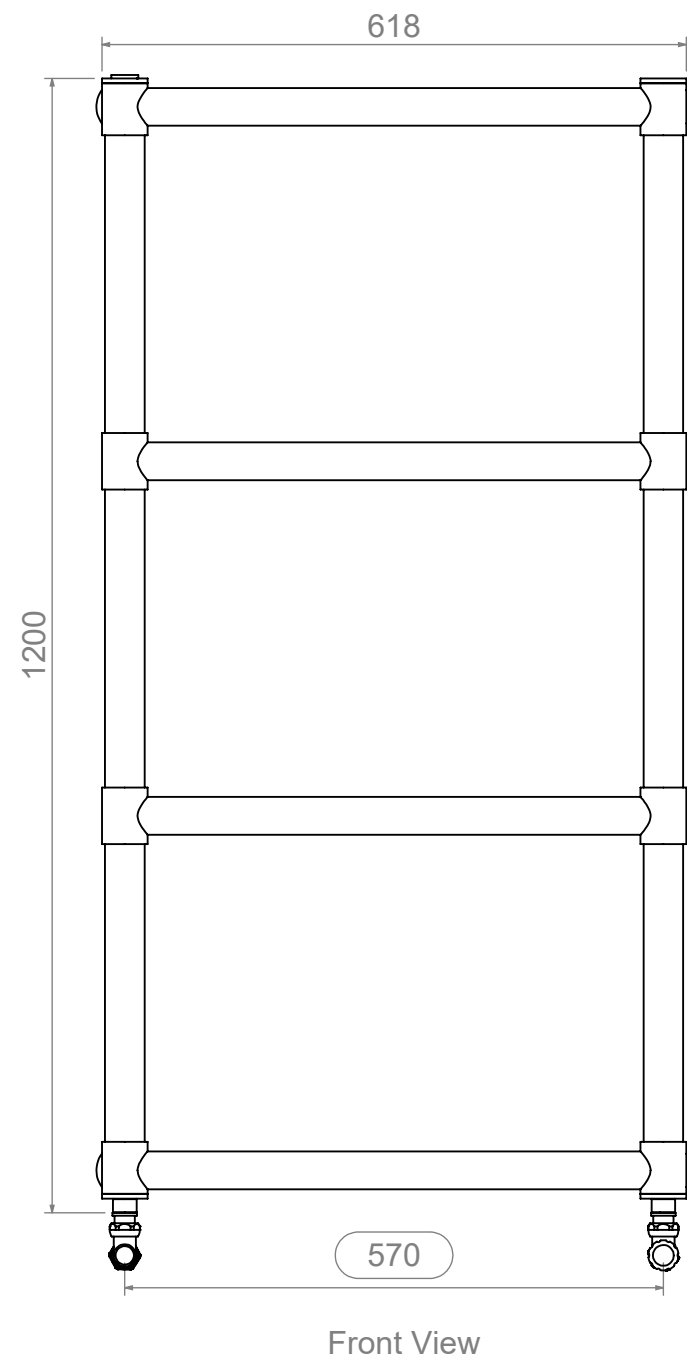
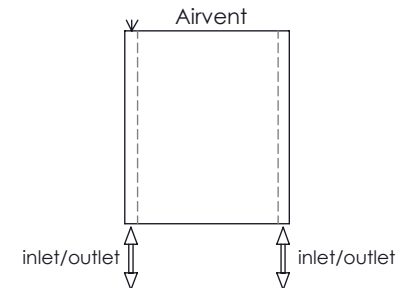

Installation Accessories:

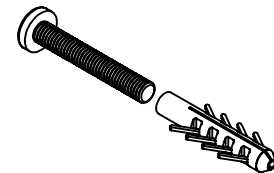

All Dimension are in mm
 Max.Working Pressure = 10 Bar
 Max.Working Temperature=95° C
 Inlet / Outlet : 1/2" BSP