

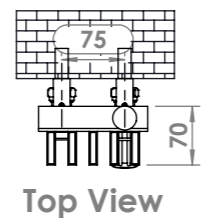

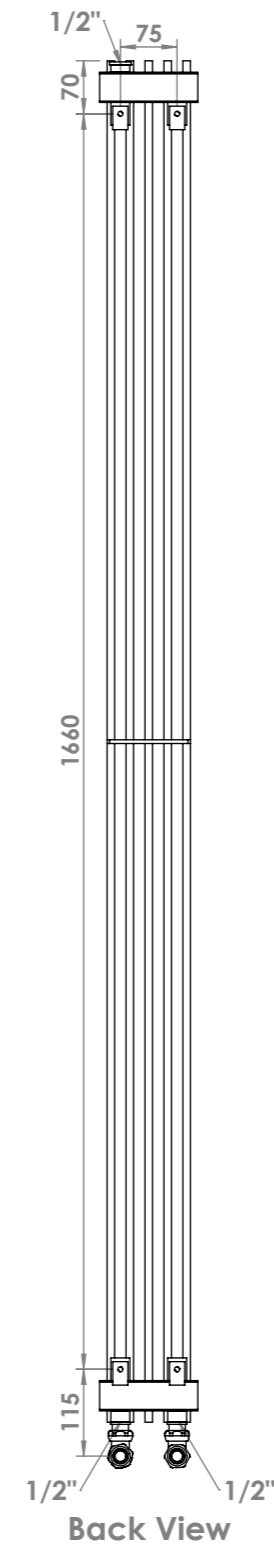

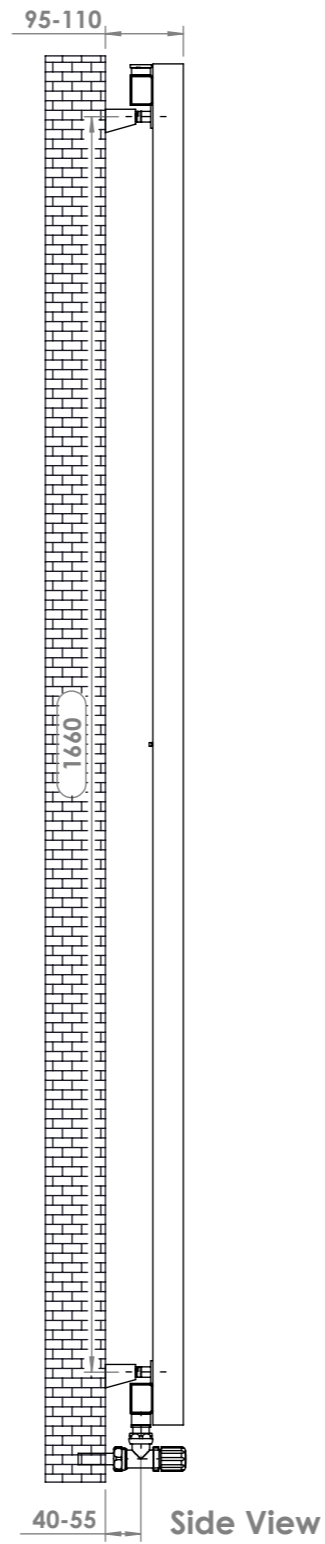

# VENETIAN 1805

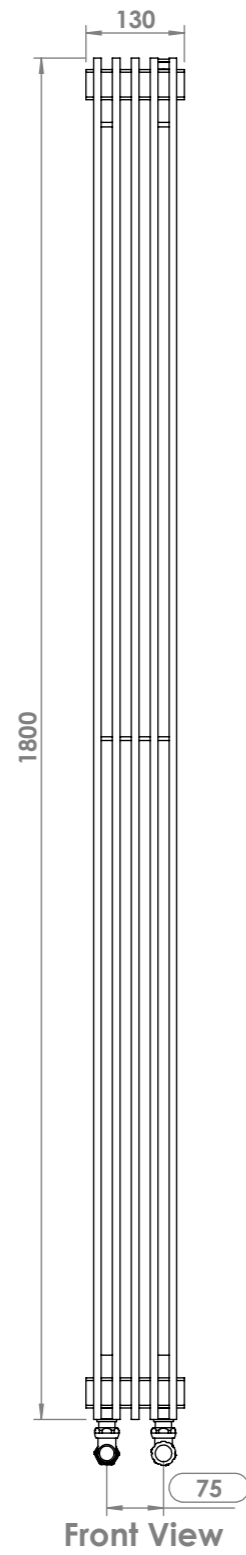

## Installation Accesories:

- |   |    |   |    |
|---|----|---|----|
|  | x4 |  | x4 |
|  | x4 |  | x4 |
|  | x4 |  | x1 |

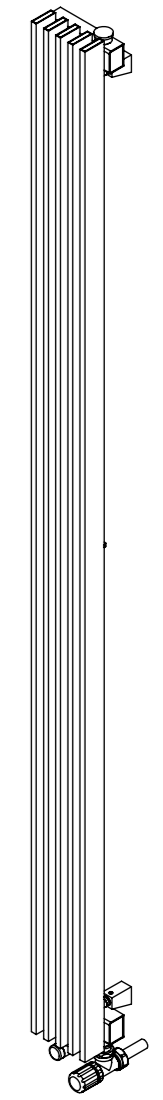
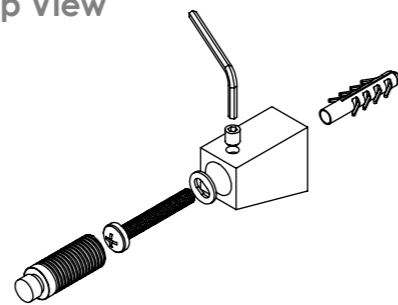

## Fitting Position:

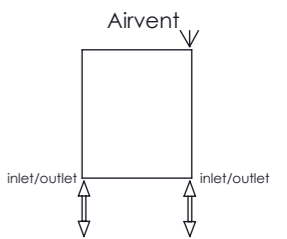

All Dimension are in mm  
 Max.Working Pressure = 10 Bar  
 Max.Working Temperature=95° C  
 Inlet / Outlet : 1/2" BSP