

# Vera 508x5-REV01

REVISIONS				
ZONE	REV.	DESCRIPTION	DATE	APPROVED
	00	AÇIKLAMA	01.01.2011	ONAYLAYAN
	01	Kollektör pul çıkarma yapıldı	8.03.2021	S.KOMAN

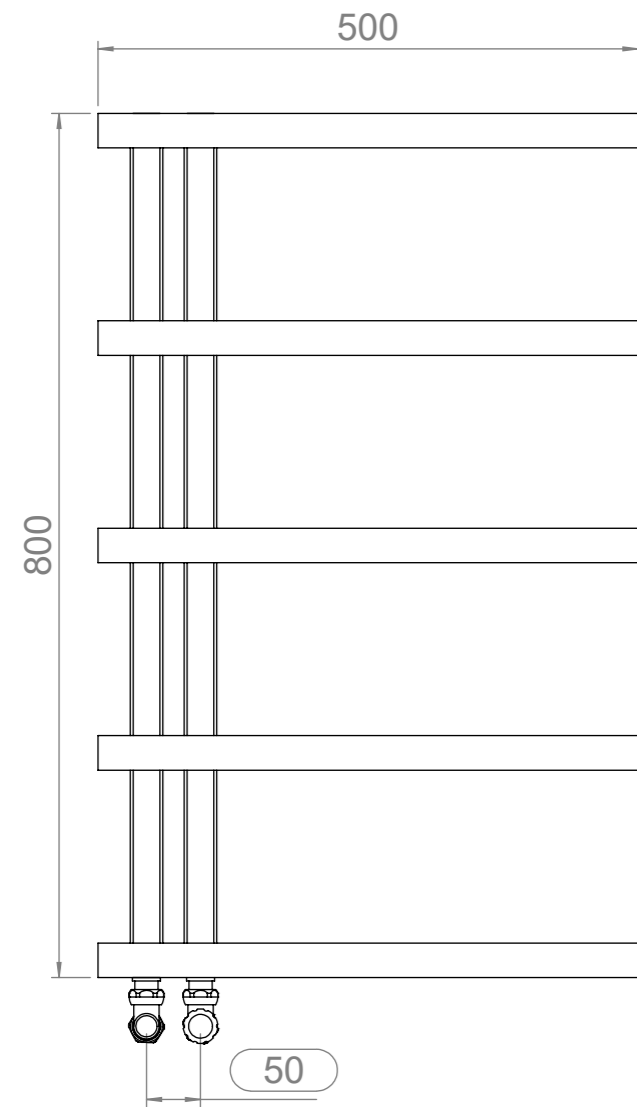

Front View

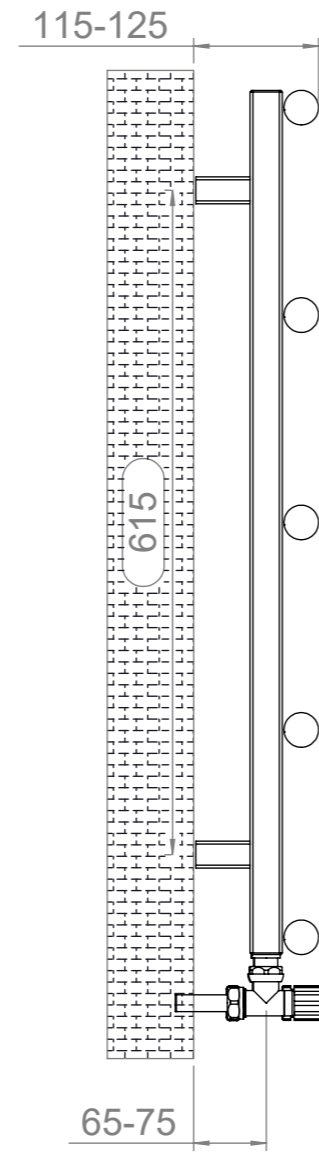

Side View

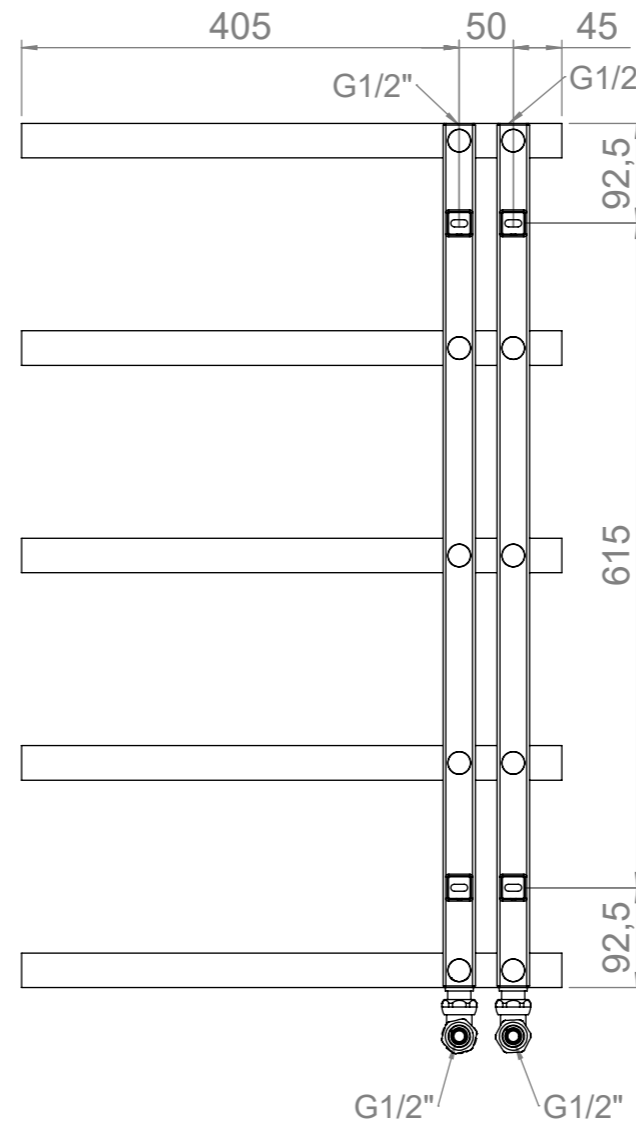

Back View

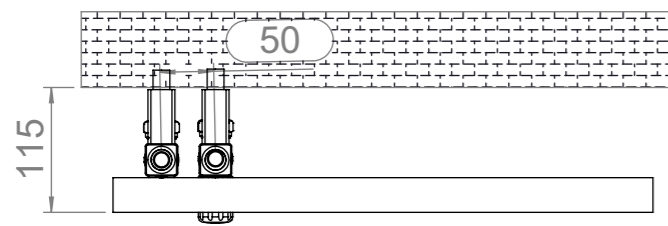

Top View

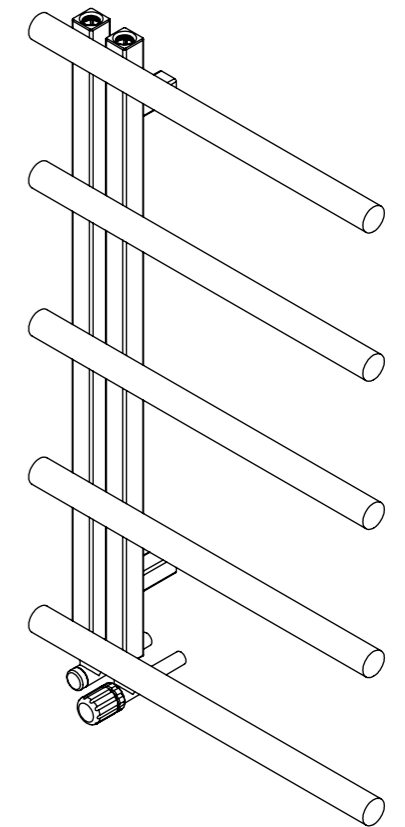

## Installation Accesories:

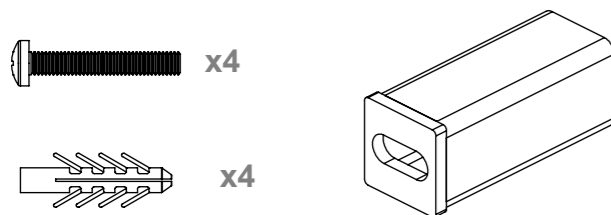

## Fitting Position:

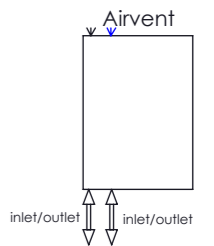

Vertical Mount  
 All Dimension are in mm  
 Max.Working Pressure = 10 Bar  
 Max.Working Temperature=95° C  
 Inlet / Outlet : 1/2" BSP  
 Fuel: H